



## SPF 6000 ES Plus New Generation Off-grid PV Inverter



SHENZHEN GROWATT NEW ENERGY CO.,LTD

**G**ROWATT

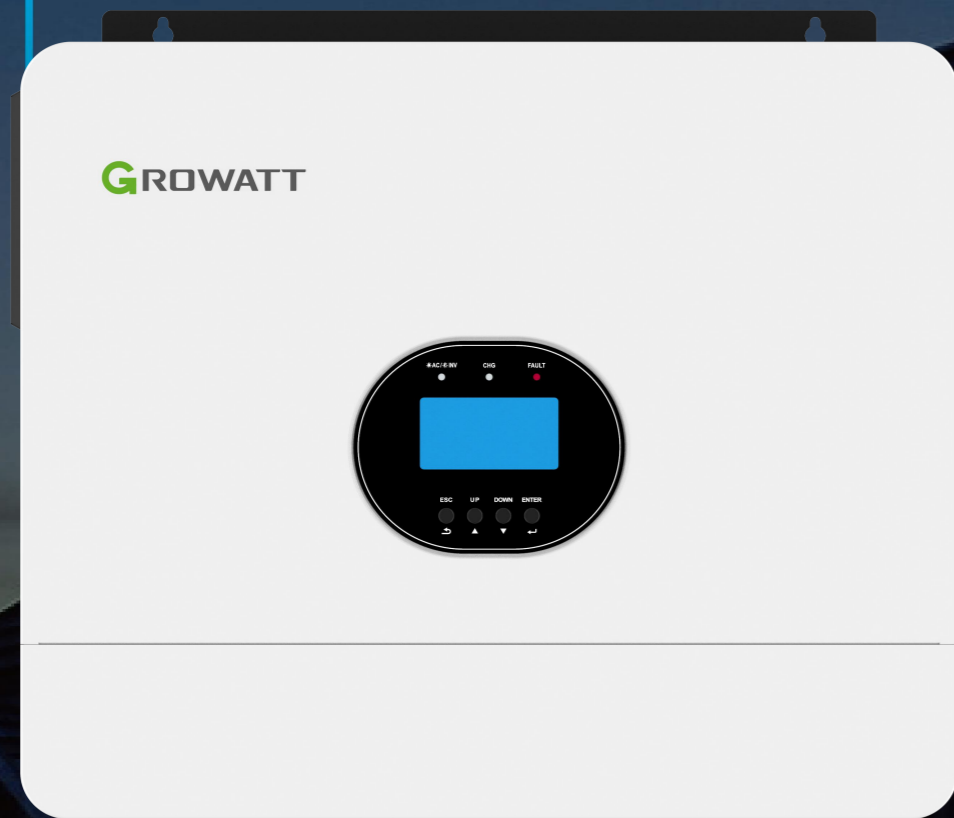

# CONTENTS

---

- 01 Product Overview
- 02 Higher Yield
- 03 Scalable & Flexible
- 04 Smart & Reliable
- 05 Application Scenarios



01

# Product Overview



# Off-Grid Energy Storage System

Off-grid energy storage system generally consist of PV modules, off-grid inverter, battery, generator and utility power, monitoring devices ,electrical appliances.

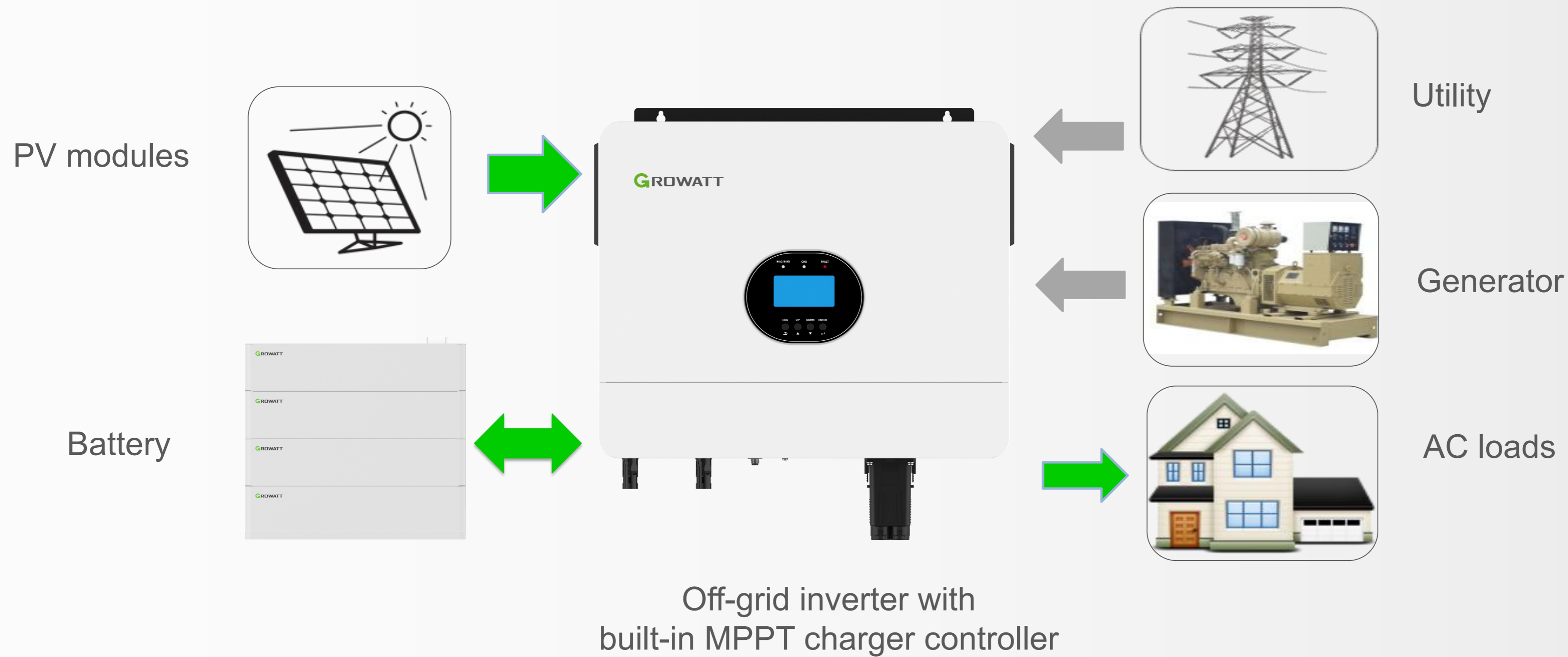



SPF 6000 ES Plus

## Key Features

1. Dual MPP trackers
2. Plug-and-Play terminal for PV port
3. Two AC input terminals with integrated transfer switch
4. Dust-proof filter for harsh environment
5. PV input voltage up to 500VDC
6. Adjustable inverter charging and output time
7. Equalization charging function
8. Configurable output and charging priority
9. SUB working mode
10. Parallel operation available up to 6 units
11. Compatible with lithium battery
12. Work with battery or without battery

# ES Plus Advantages

## Inverter parameters:



SPF 3000-5000 ES



SPF 6000 ES Plus

Model	SPF 3000-5000 ES	SPF 6000 ES Plus	Benefits
Parameters			
Maximum PV array open circuit voltage	450V	<b>500V</b>	Each string can be connected to more modules,PV input power up to 8000W
No. of MPP trackers	1	<b>2</b>	PV module strings can be installed at different orientations
Max. PV input current	22A	<b>32A(16/16)</b>	More PV strings can be connected to increase input capacity, compatible with 500+ PV module
AC input source	Utility power or generator	<b>Utility power and generator</b>	No need for the extra ATS device to connect between inverter and the AC source
PV terminal	Wire connection	<b>MC4 connection</b>	Easy and tighten the connection, saving installation time
Air flow	Without filter	<b>Dust-proof design</b>	Prevent inverter faults caused by the excessive dust and easy for maitenance



# 02

Higher Yield



# Power Factor 1.0



More Powerful

Output power factor: 1.0 (6KVA & 6KW)

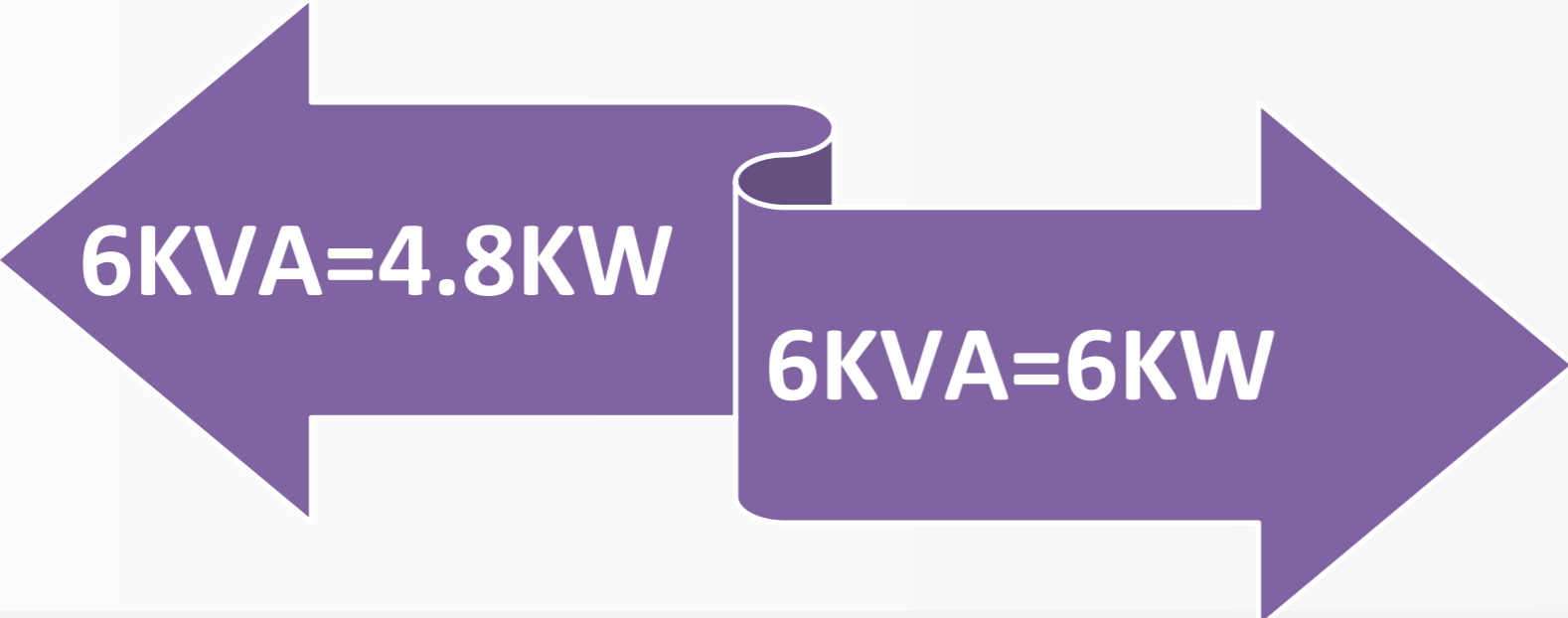

Power factor : 0.8

Over-load 125%, inverter stop working

Power factor : 1.0

Inverter 100% load, still work normally

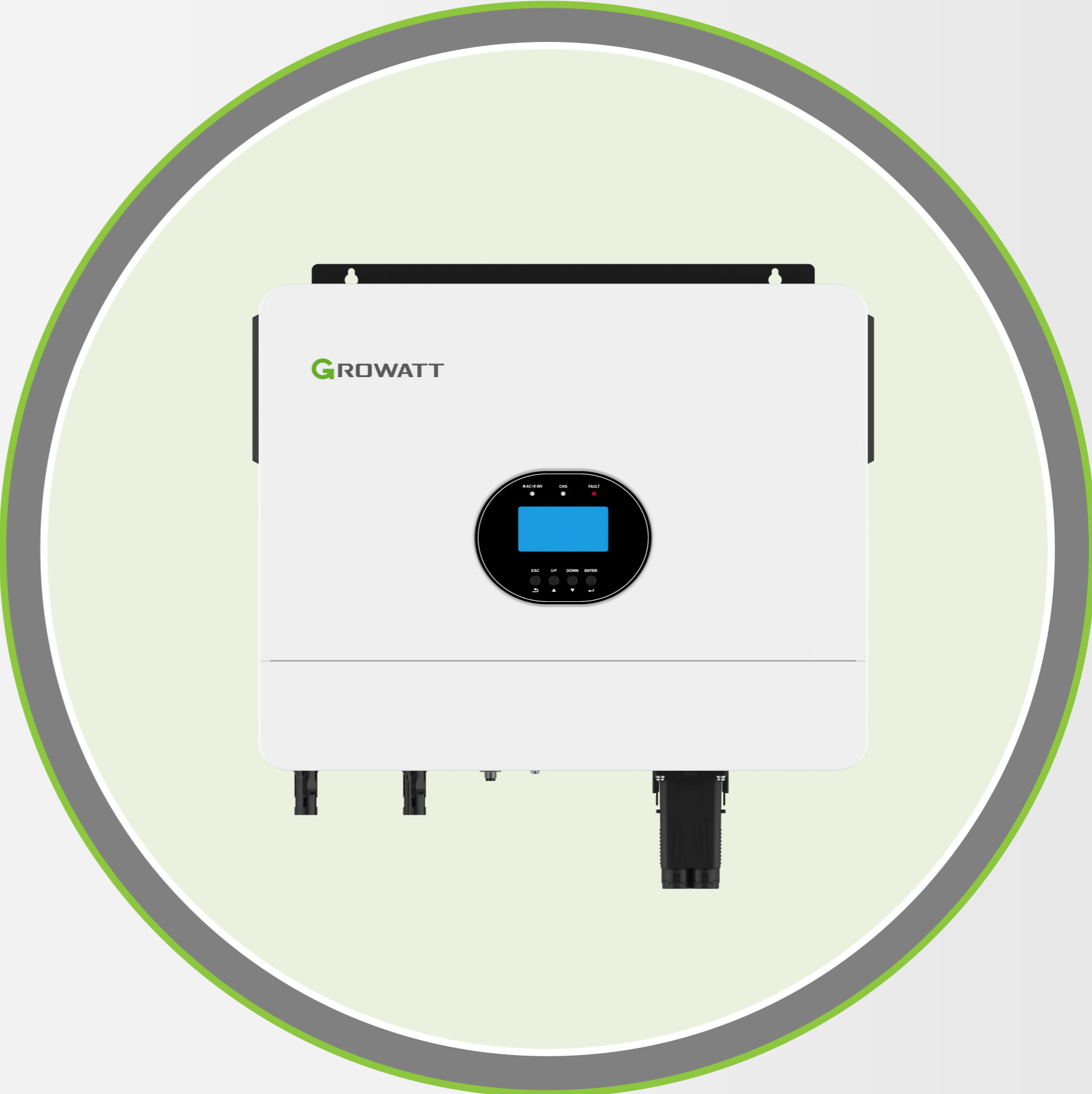



# More Powerful PV Input

The maximum 8KW PV output capability for ES Plus ,when solar power is sufficient the 6kw output power for loads and the excess 2kw power will charging for the battery.

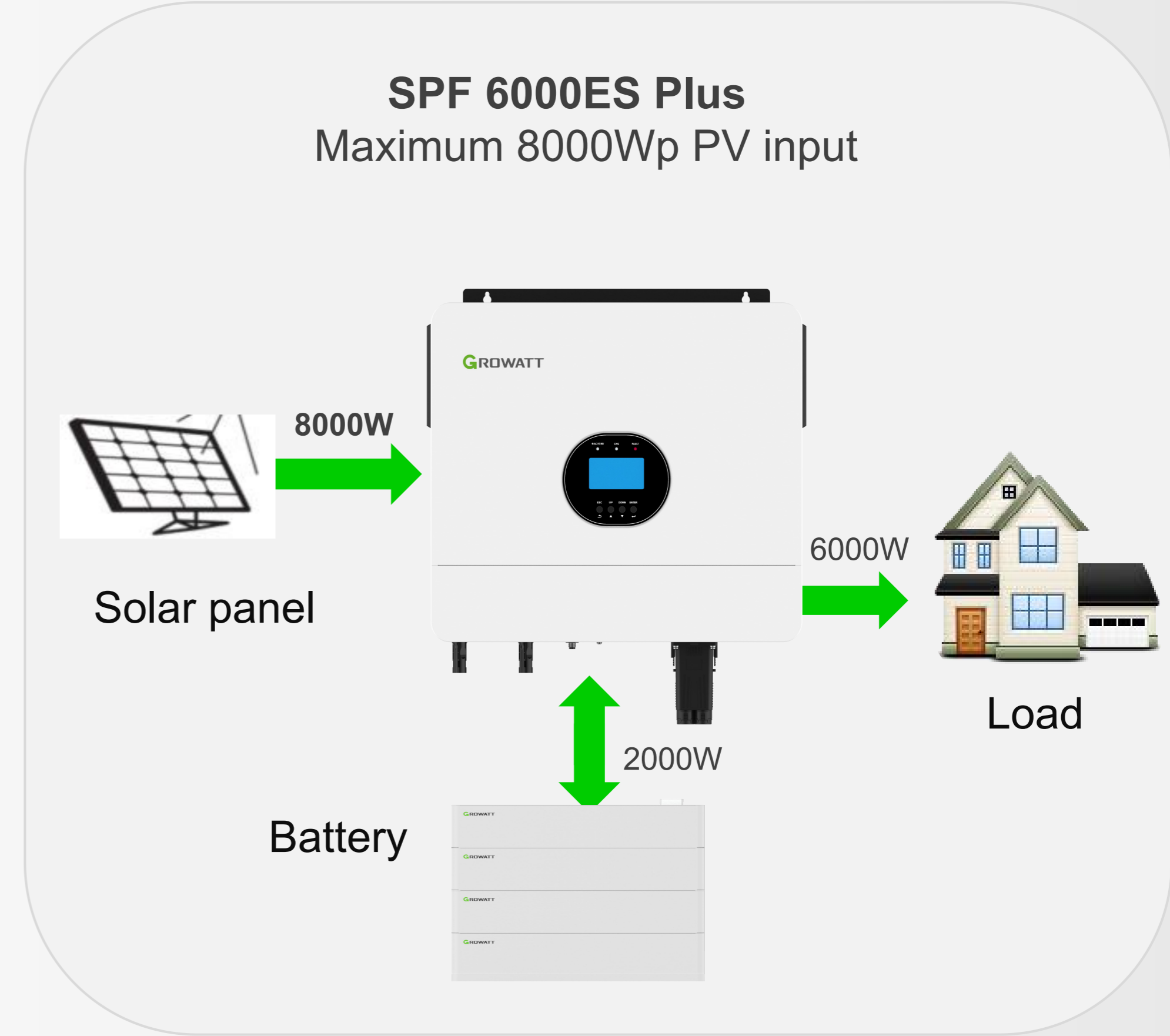
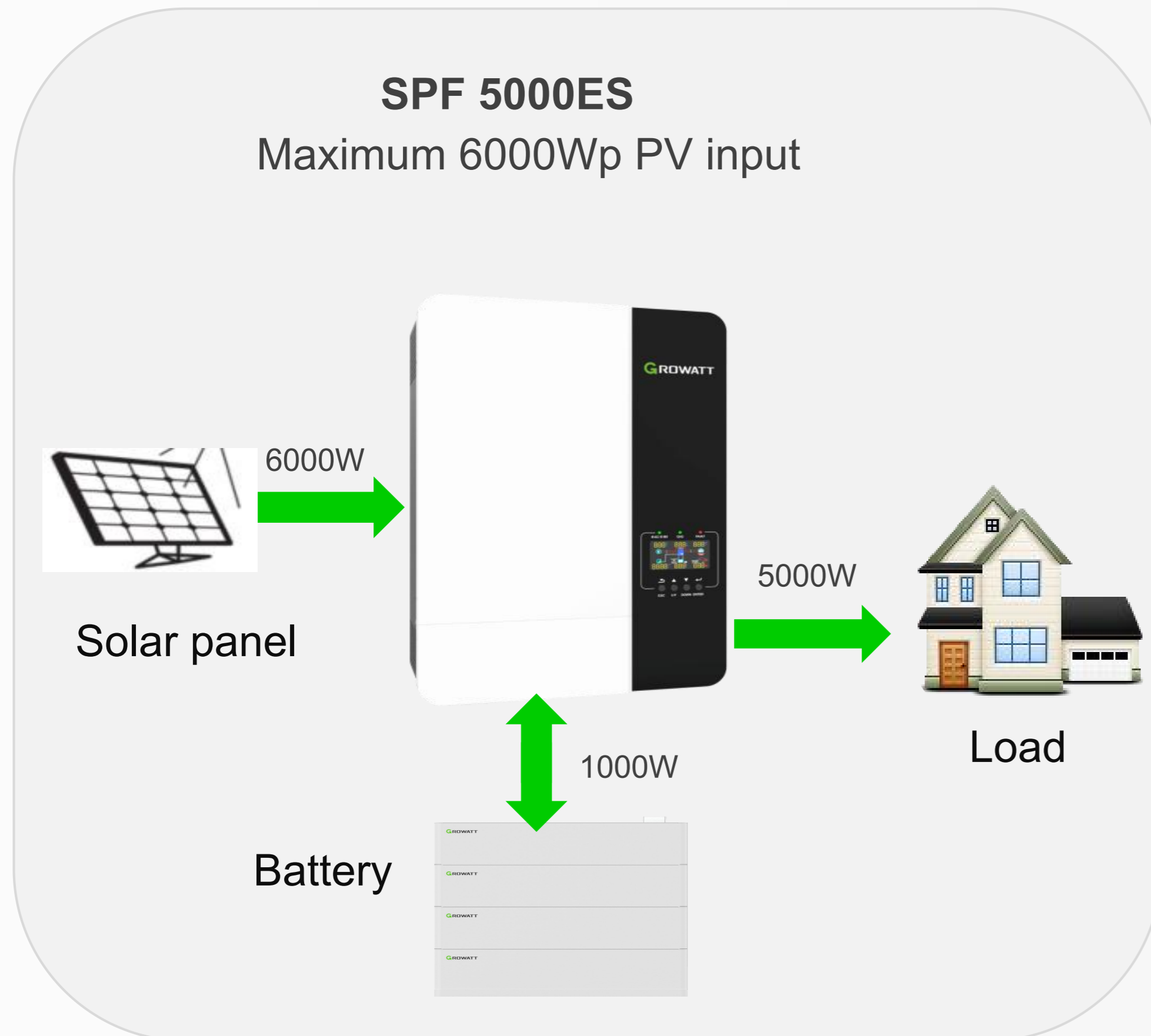

# Higher PV Input Voltage and Current

## Inverter configuration:

Max. PV input current and open circuit voltage

- ES series inverter: 22A / 450V(One MPPT)
- ES Plus inverter: 32A / 500V (Two MPPTs)

Maximum Power- $P_{MAX}$ (Wp)	401	405	409	413	417	420
Maximum Power Voltage- $V_{MPP}$ (V)	28.6	28.8	29.0	29.2	29.3	29.5
Maximum Power Current- $I_{MPP}$ (A)	14.01	14.06	14.10	14.15	14.19	14.23
Open Circuit Voltage- $V_{oc}$ (V)	35.0	35.1	35.3	35.5	35.7	35.9
Short Circuit Current- $I_{sc}$ (A)	14.76	14.80	14.84	14.88	14.92	14.96



SPF 5000 ES

Max. PV current 22A configuration(420W)

- 12PCS in series : 5040W input (5040W output)
- 7PCS in series, 2string for parallel : 5880W input (4543W output)
- **10PCS in series, 2string for parallel : 8400W input (6000W output)**



SPF 6000 ES Plus

Max. PV current 32A configuration(420W)

- 7PCS in series, 2string for parallel : 5880W input (5880W output)
- **10PCS in series, 2string for parallel : 8400W input (8000W output)**

# 03

**Scalable & Flexible**

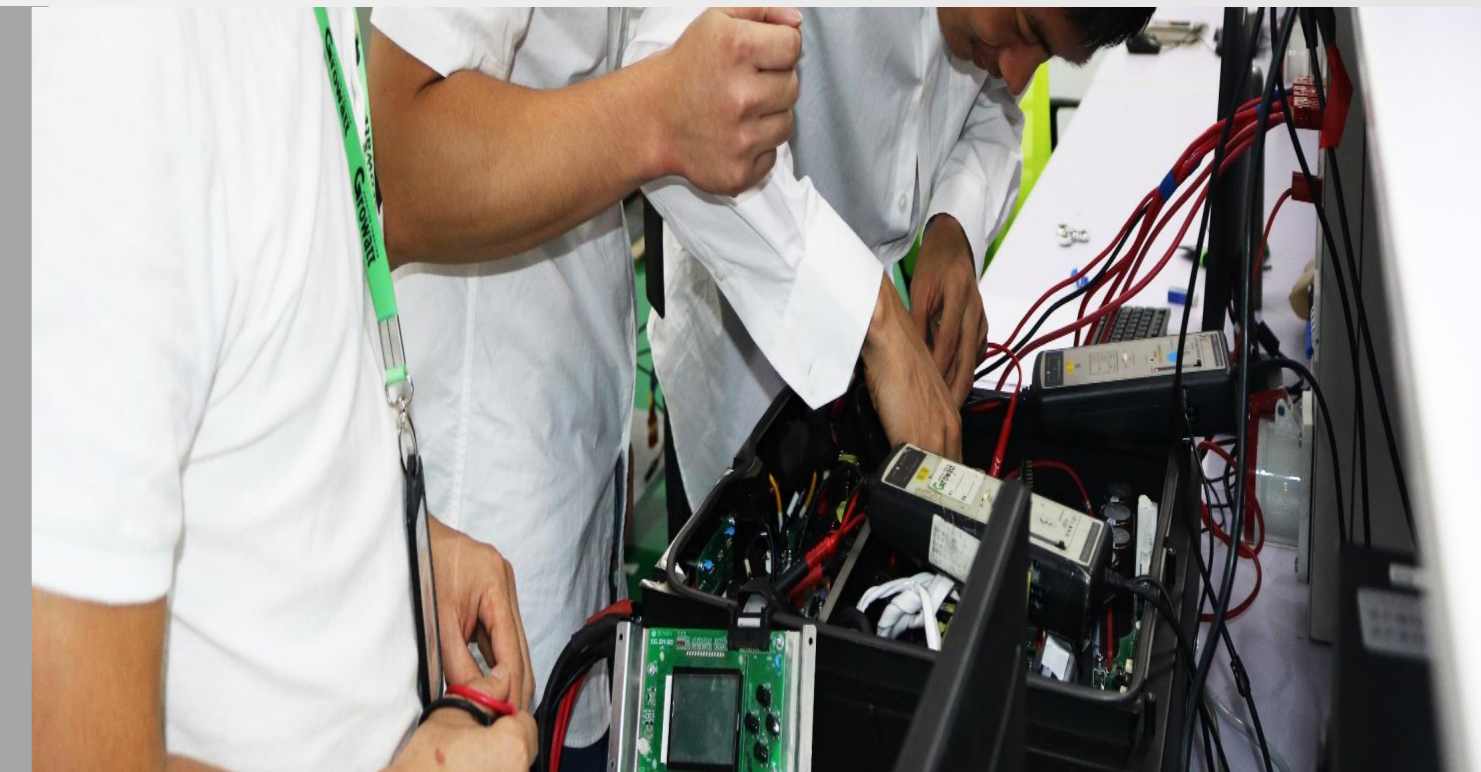



# Two AC Input Terminals

ES Plus inverter has two AC input terminals with an integrated ATS device which can meet multiple AC source input requirements.

General ES inverter only has one AC input terminal, so an extra ATS device is needed to connect between the inverter and the AC source when there are two AC source inputs.

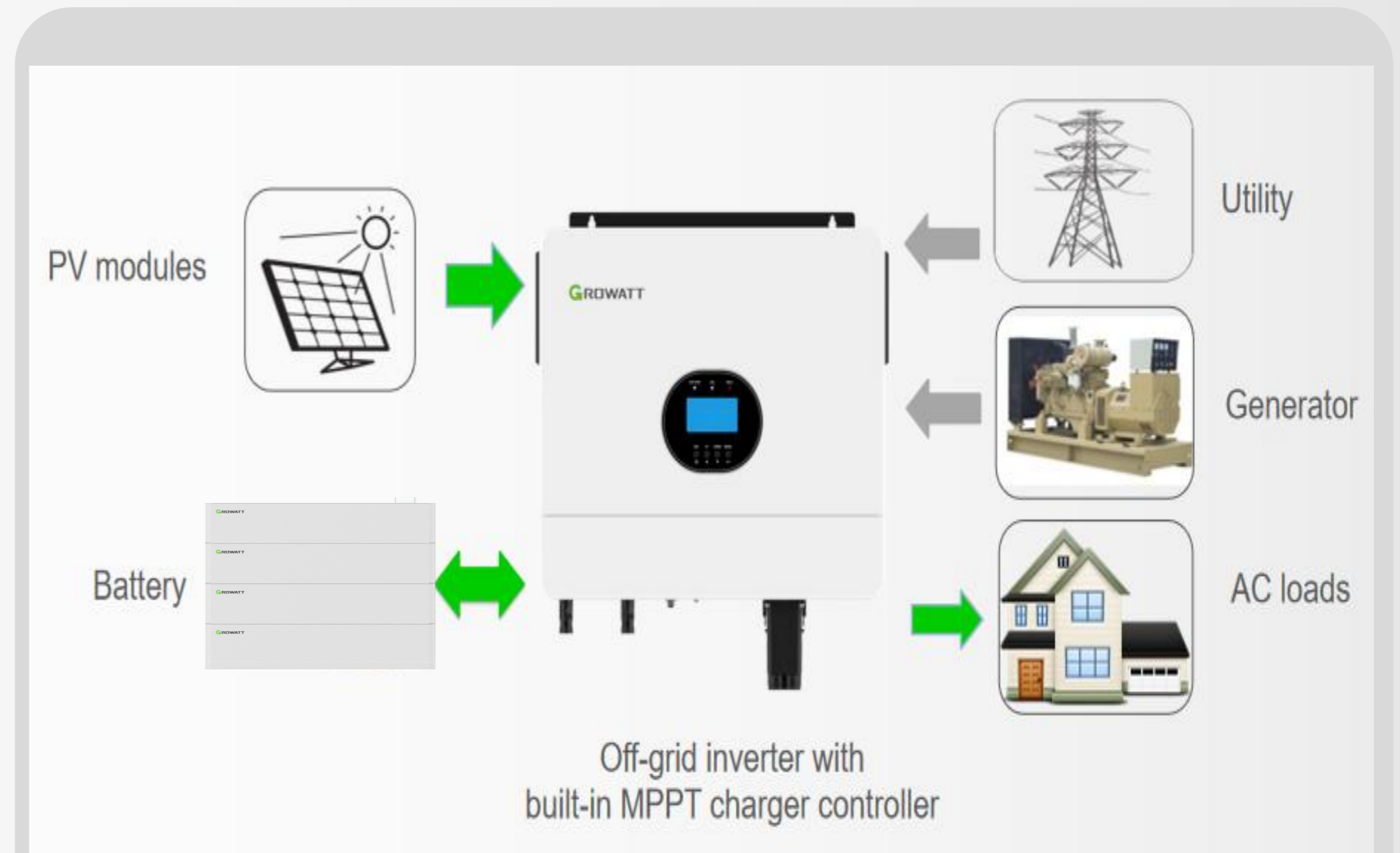
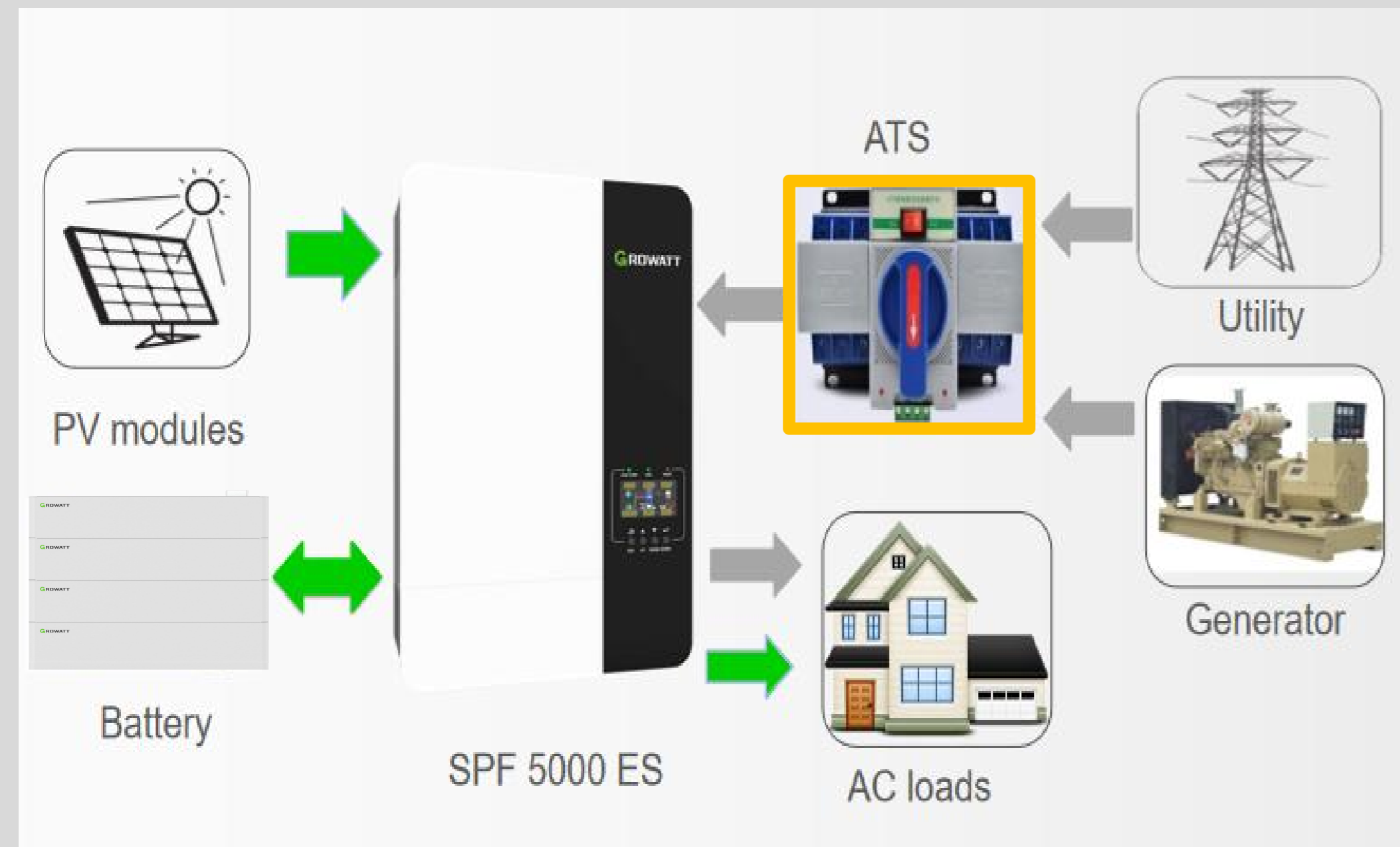

ES Plus inverter has two input terminals, so it can connect two AC source inputs at the same time and then can save the cost of an extra ATS device.



# Dual MPP Trackers

## PV module installation

General ES inverter only one MPP tracker, the PV modules installation only suitable for the same orientation



ES Plus inverter has two MPPTs design which can meet multi-orientation installation requirements.



# Parallel Extension

Parallel operation up to 6 units, the maximum system capacity would be 36kW, also support to configure three-phase system, provide customer enough flexibility.

Three-phase system

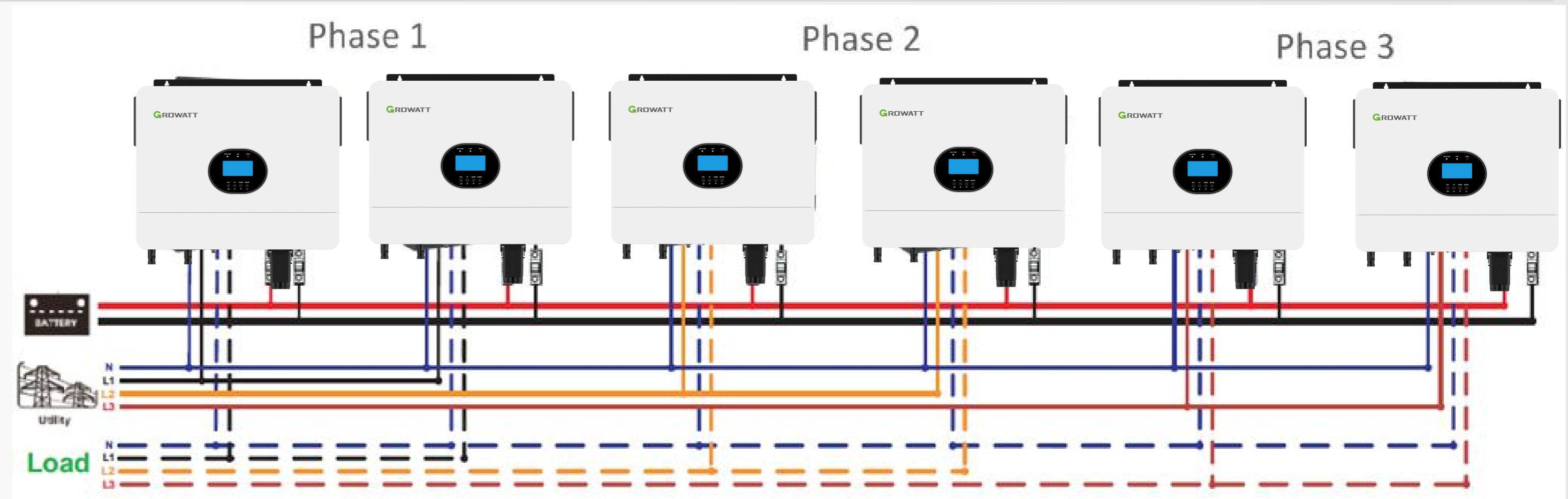

Single-phase system

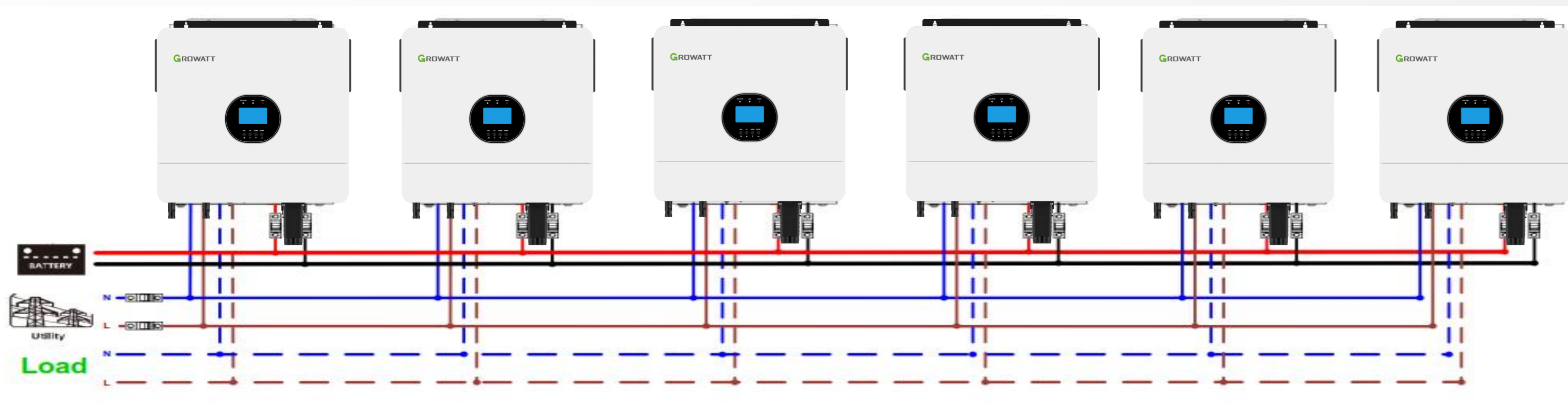



# CAN/RS485 Communication with Lithium Battery

Inverter built-in BMS port which includes RS485 and CAN communication, and then easy to connect to different communication methods of lithium batteries.

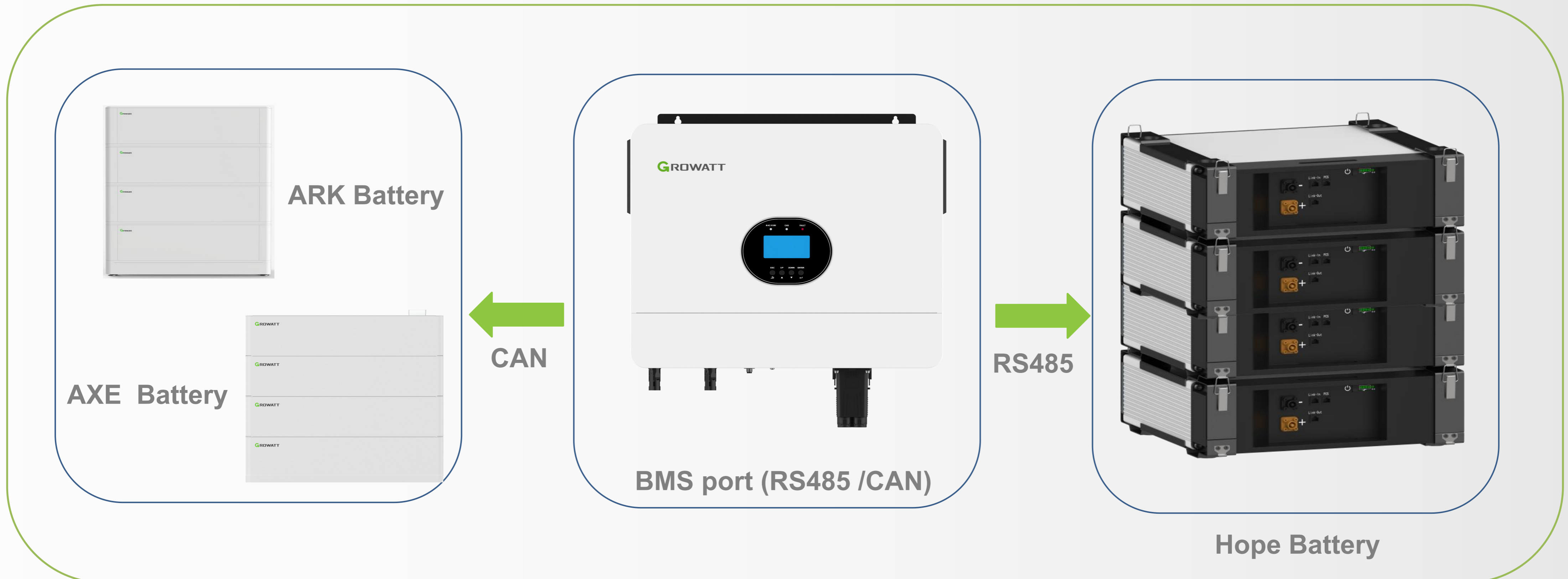

# Work Without Battery Brings Full Flexibility

Help customers to reduce the initial investment cost of the system, the new SUB mode also enables the inverter could work without the battery then solar and utility joint power to loads if solar is insufficient.

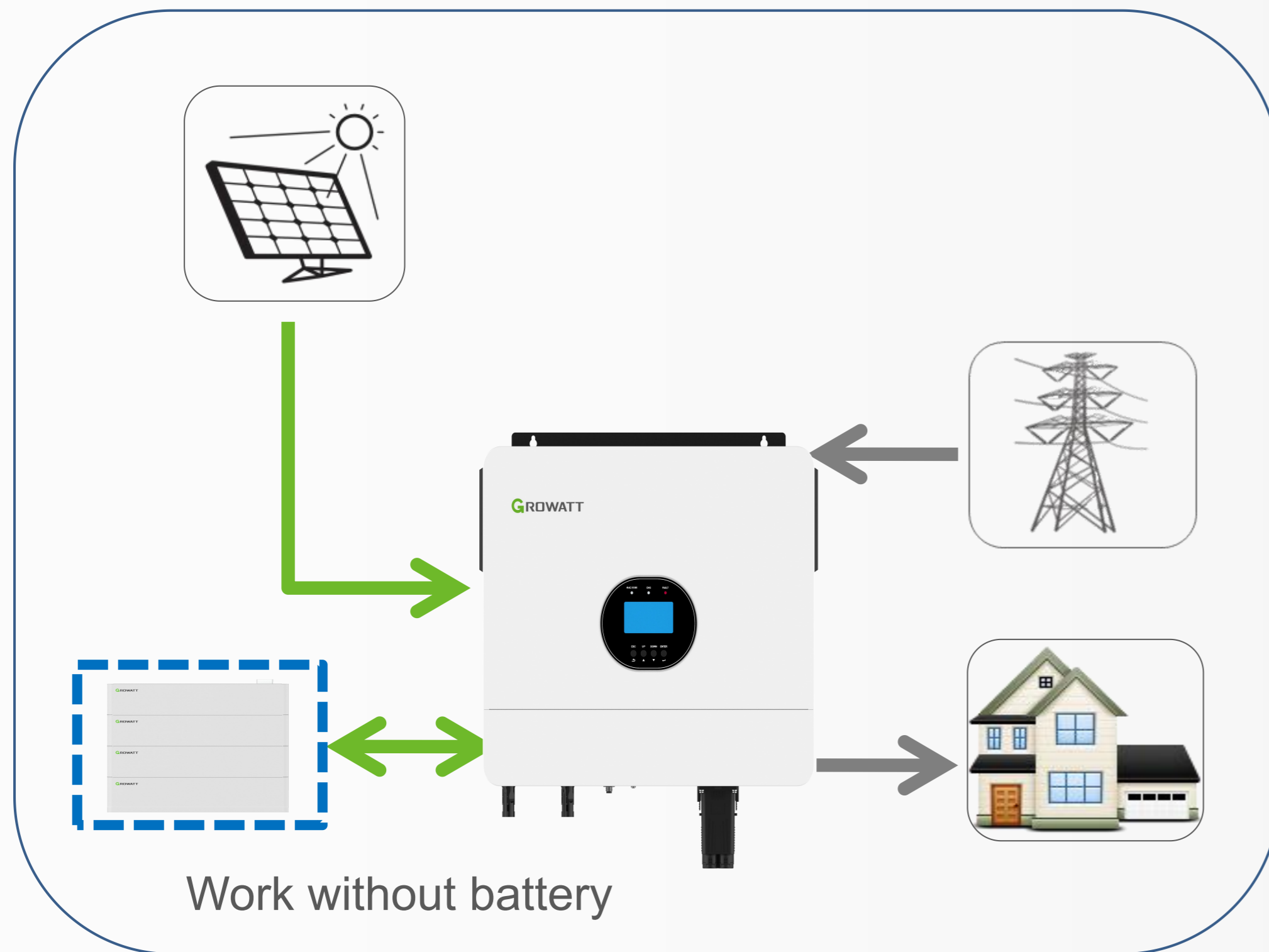

ES and ES plus series  
inverter

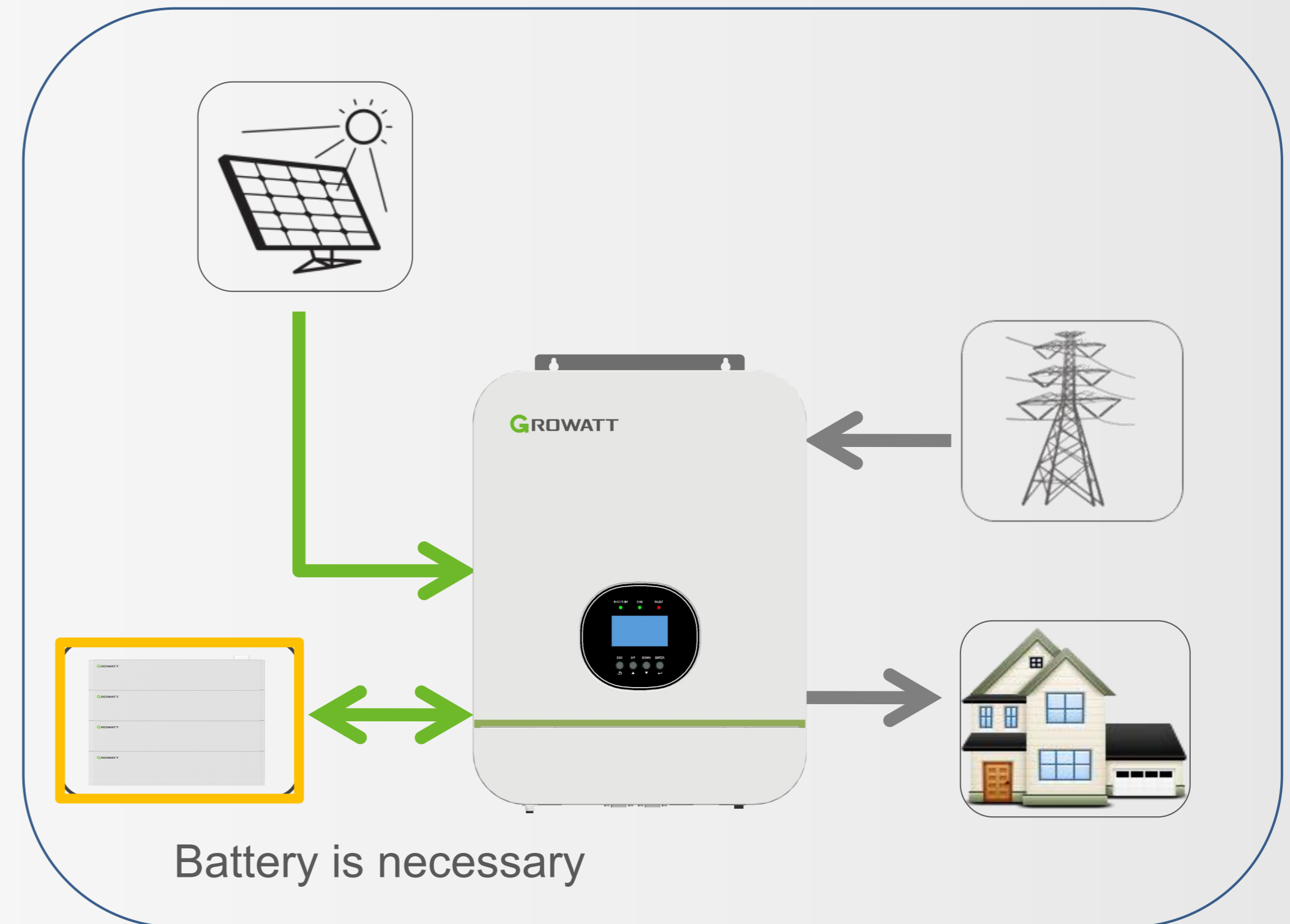

Old version inverter

# 04

Smart & Reliable

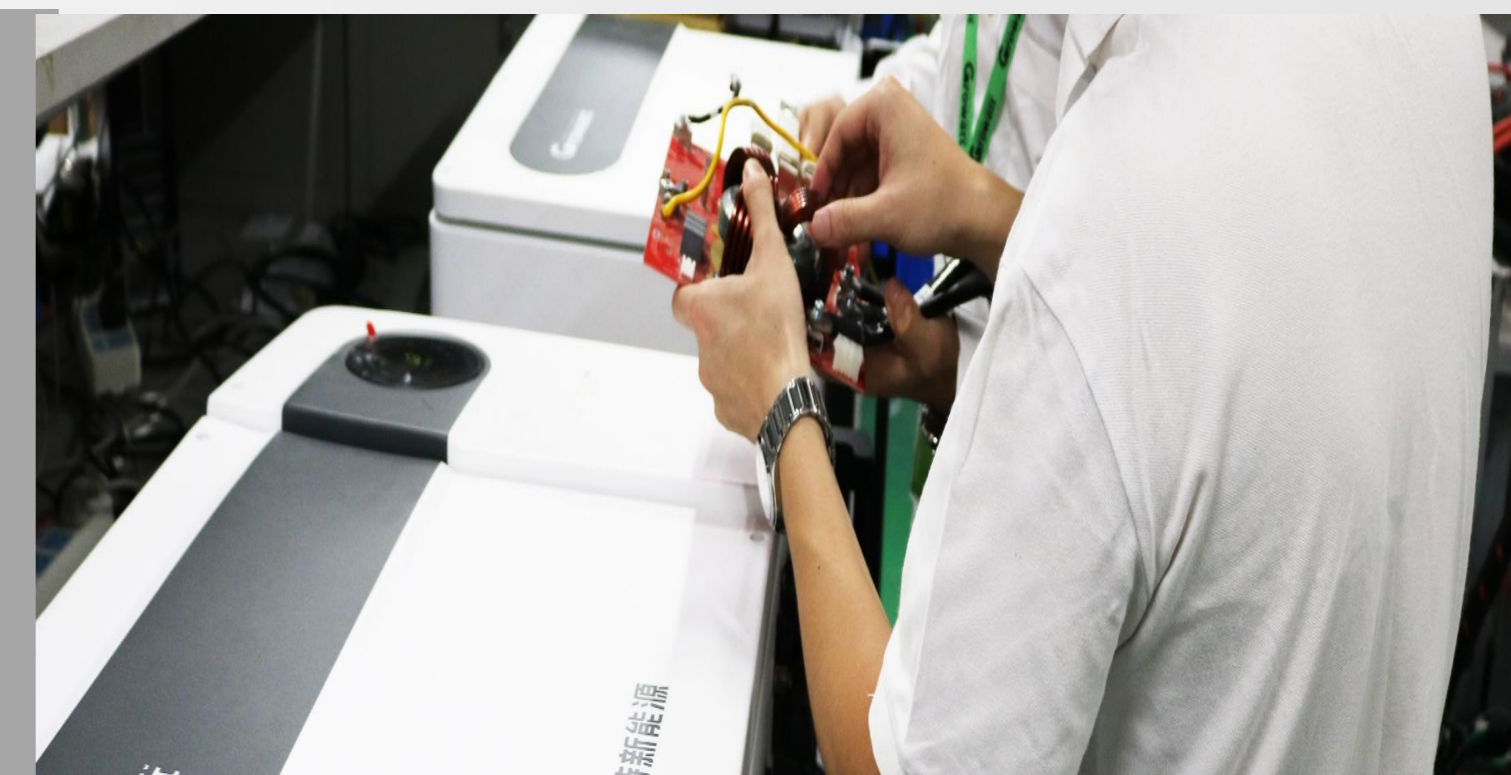



# Convenient HMI

## Colorful LCD display

### Plus series

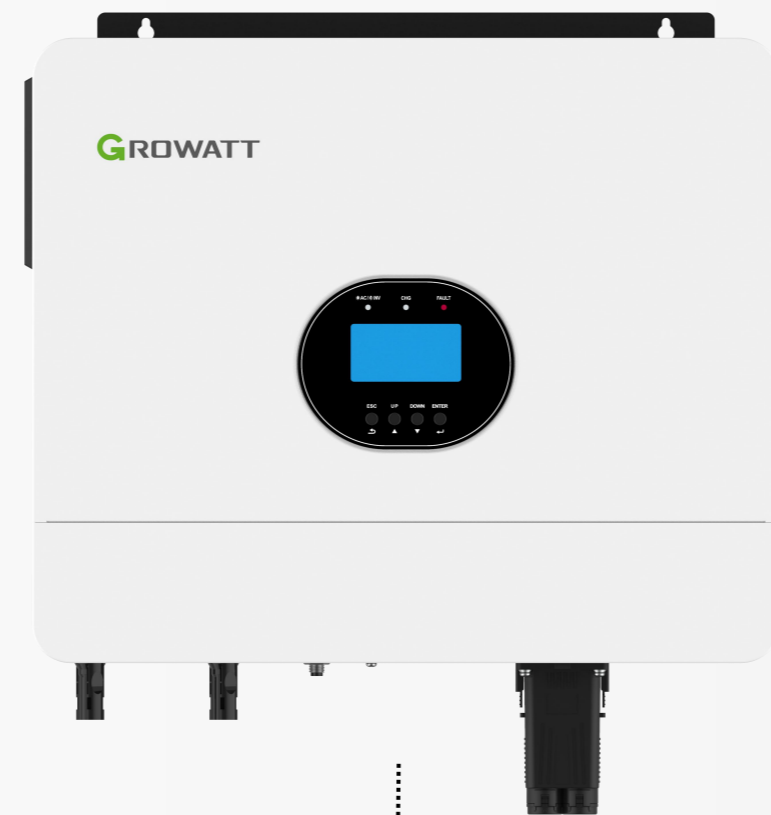
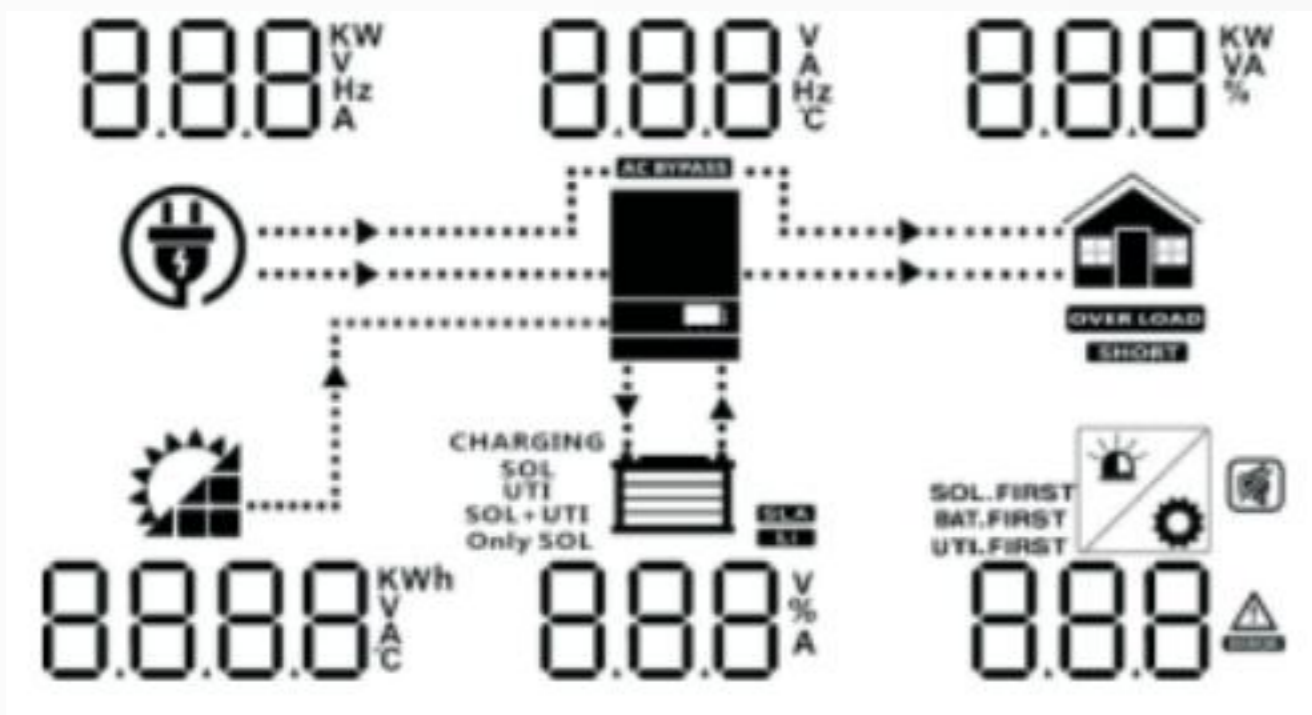

USB cable



PC install monitoring software

PVkeeper platform for local configuration or monitoring.



1. Input information (PV voltage, AC voltage, frequency, PV generation, battery voltage, charger current)

2. Output information (voltage, load percentage, frequency, load in VA, load in watt, discharging current)

# Smart Management



Remote monitoring,  
Support remote FW upgrade



WIFI, GPRS communication port for remote monitoring

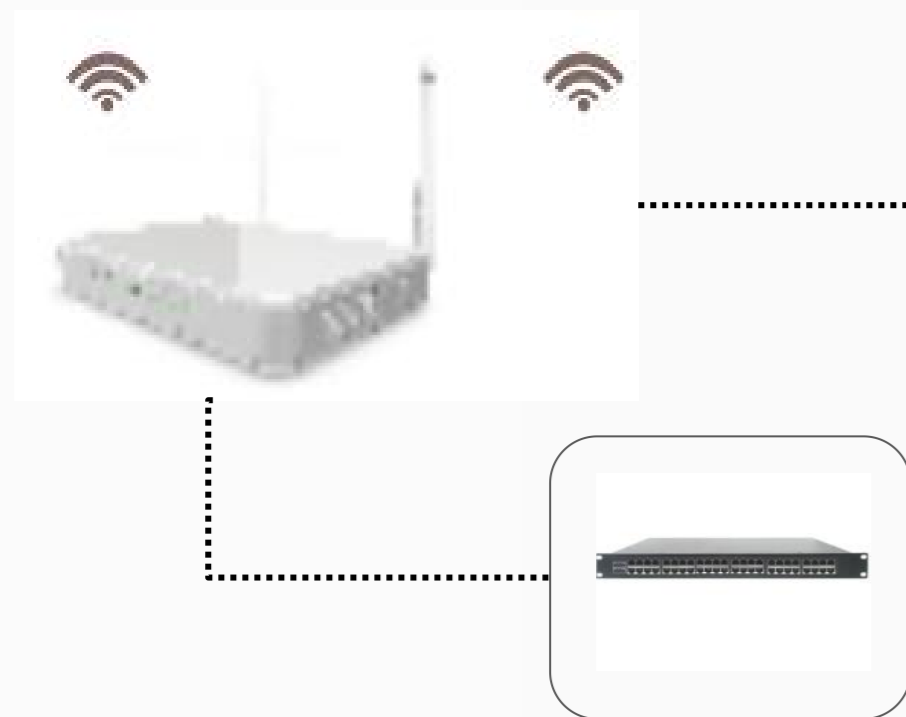

ShinePhone APP



ShineServer





# Equalization Charging

Inverter can enable battery equalization function which can set charge interval time and charge voltage to activating lead-acid battery characteristics then extend lead-acid battery life.

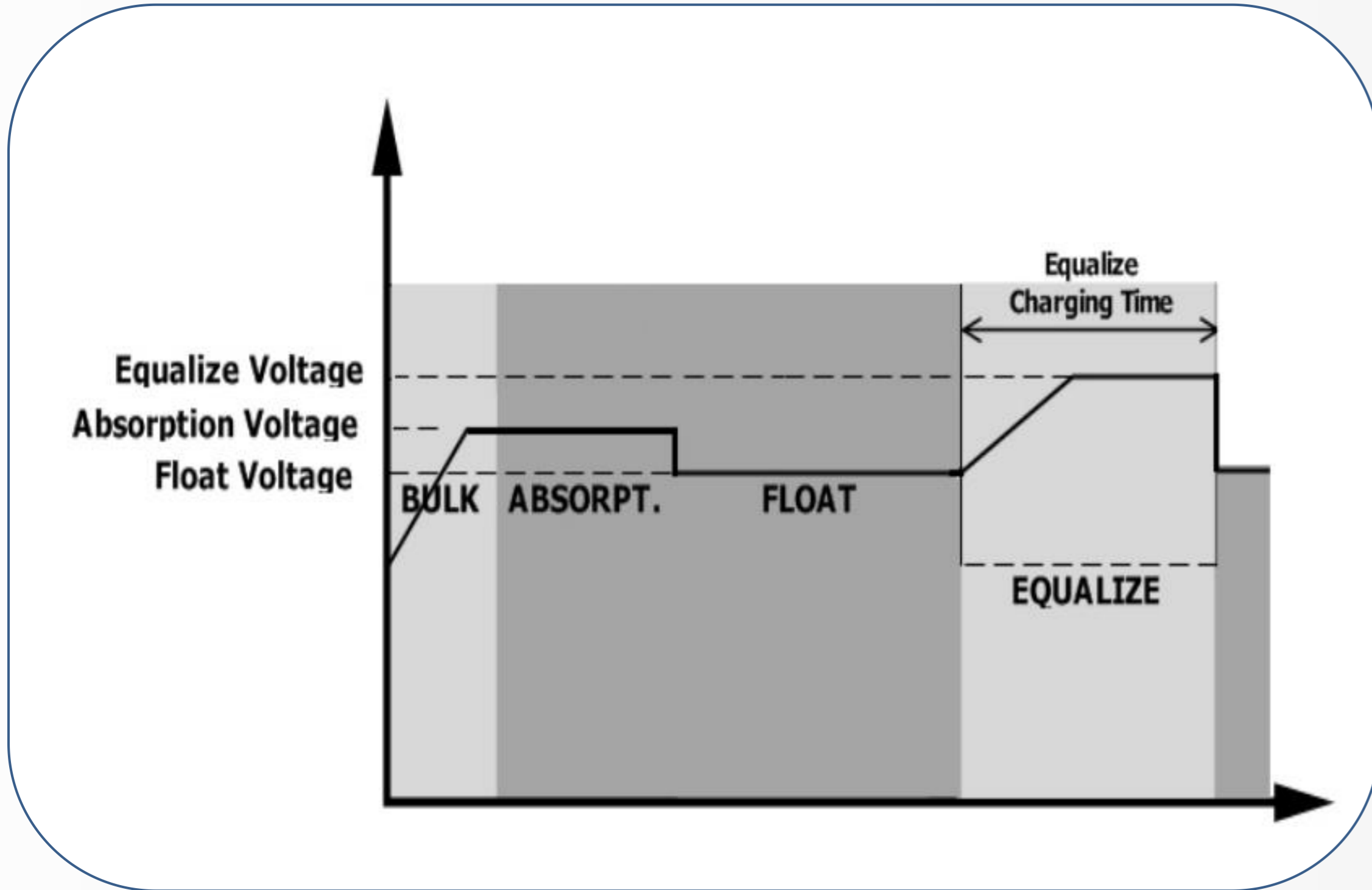

ES series inverters

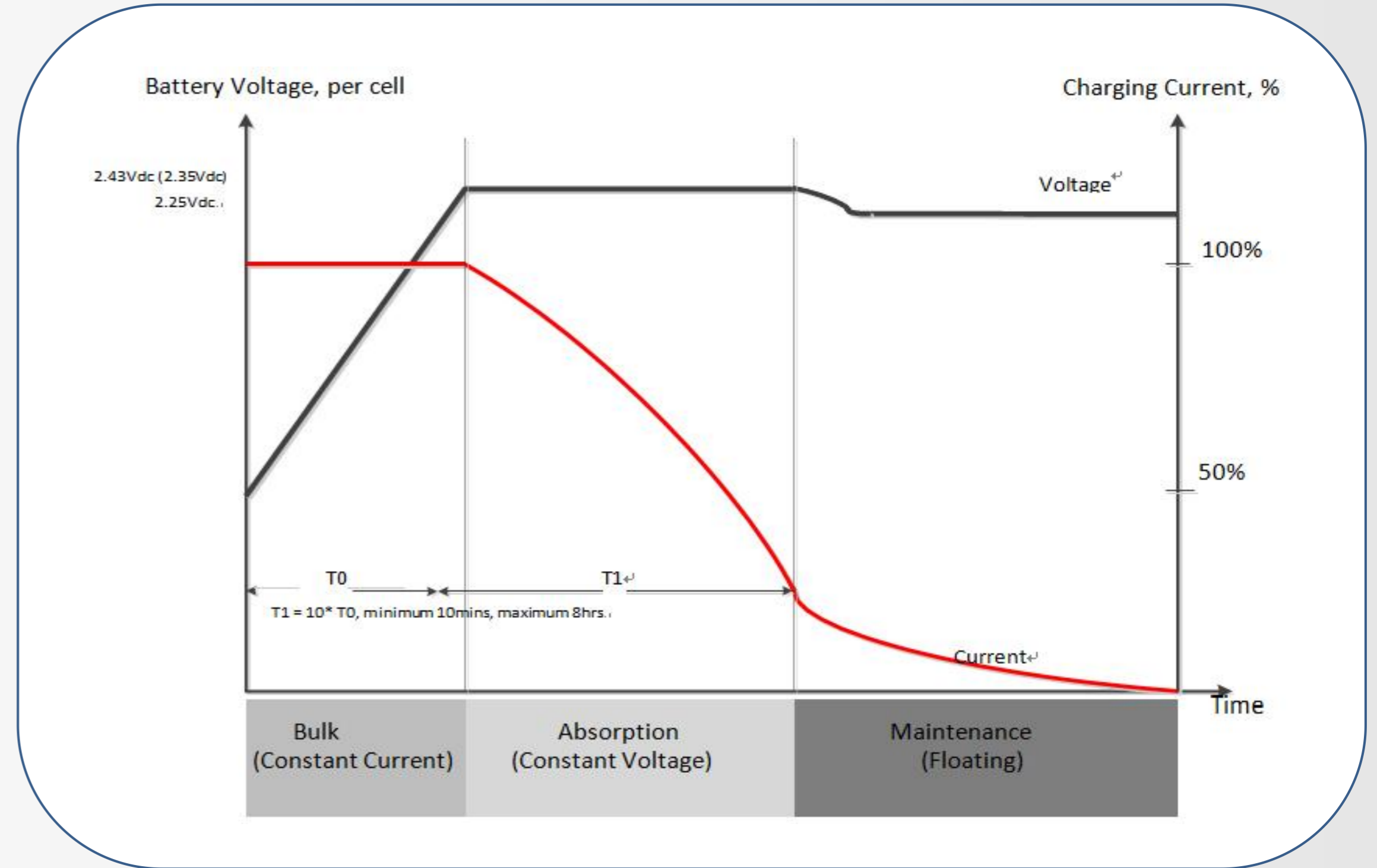

General inverter



# 05

## Application Scenarios

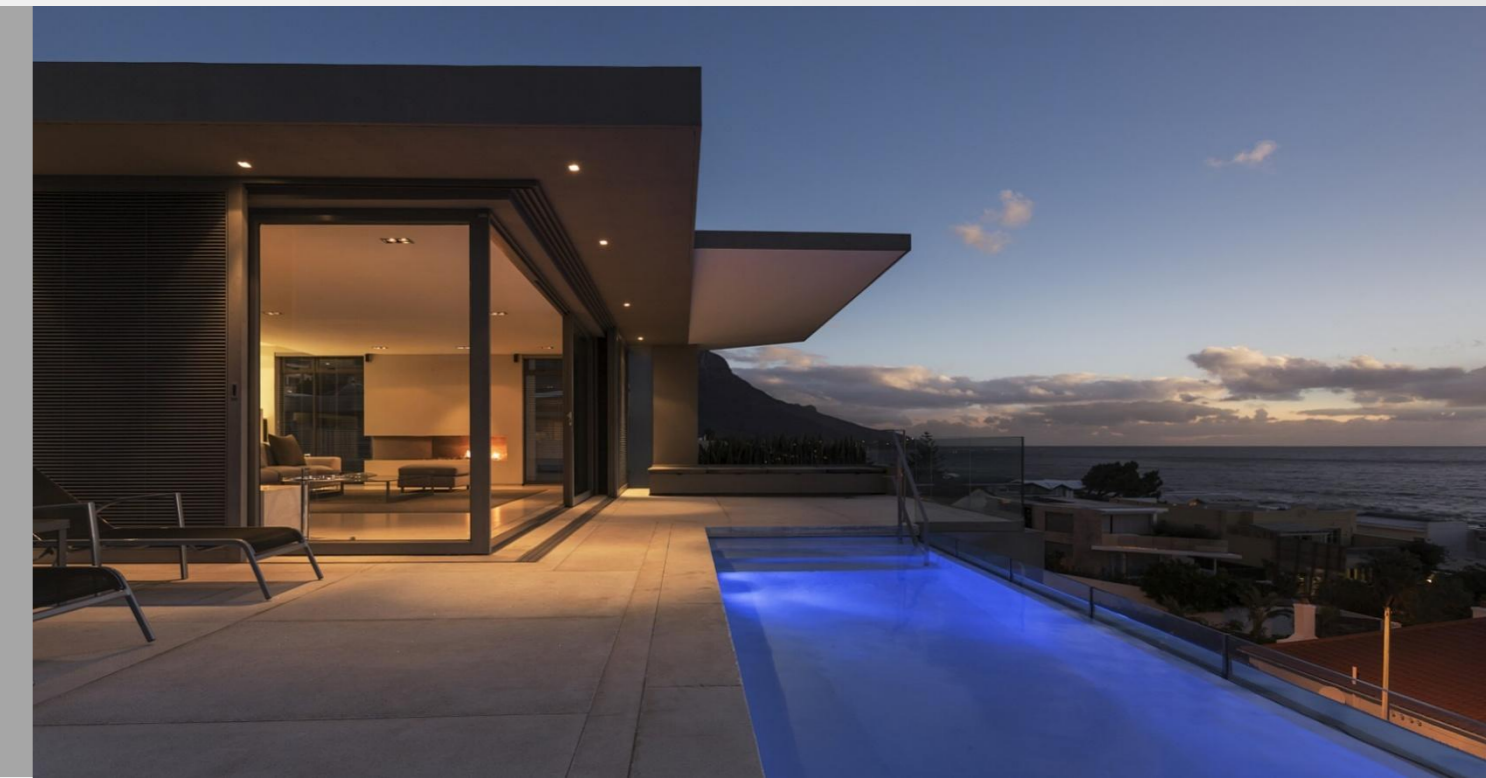

# Multiple Work Modes

Working mode: ( output SOL: solar first ; charging SNU: solar and utility power)

## 1. Solar power is sufficient

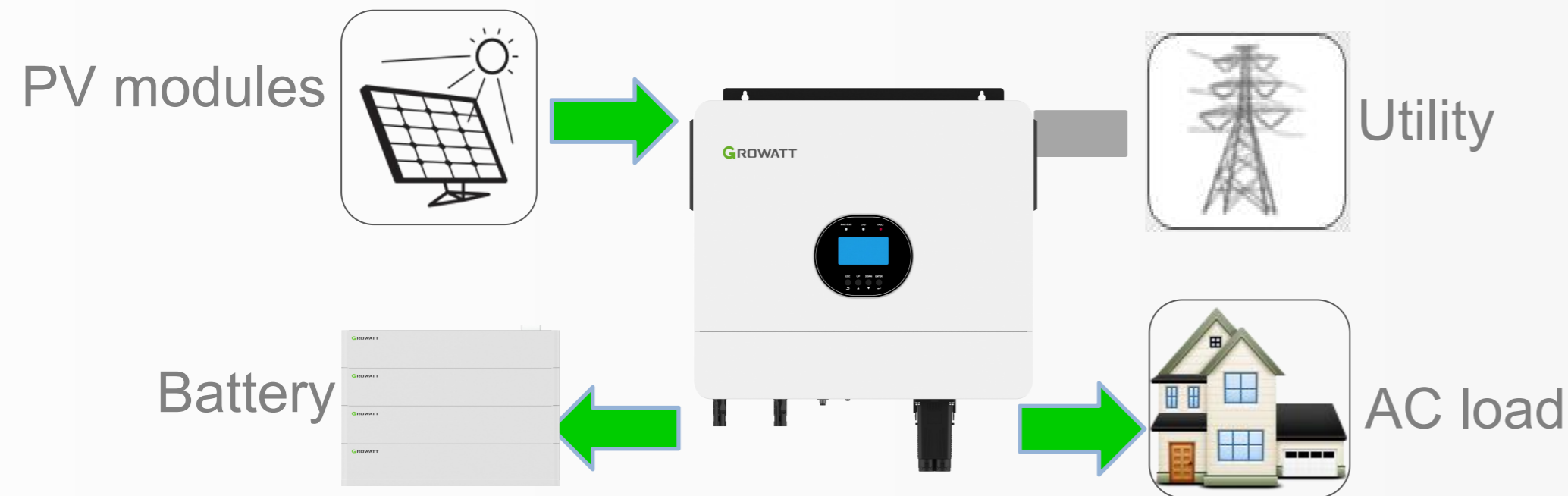

## 2. Solar power is not sufficient

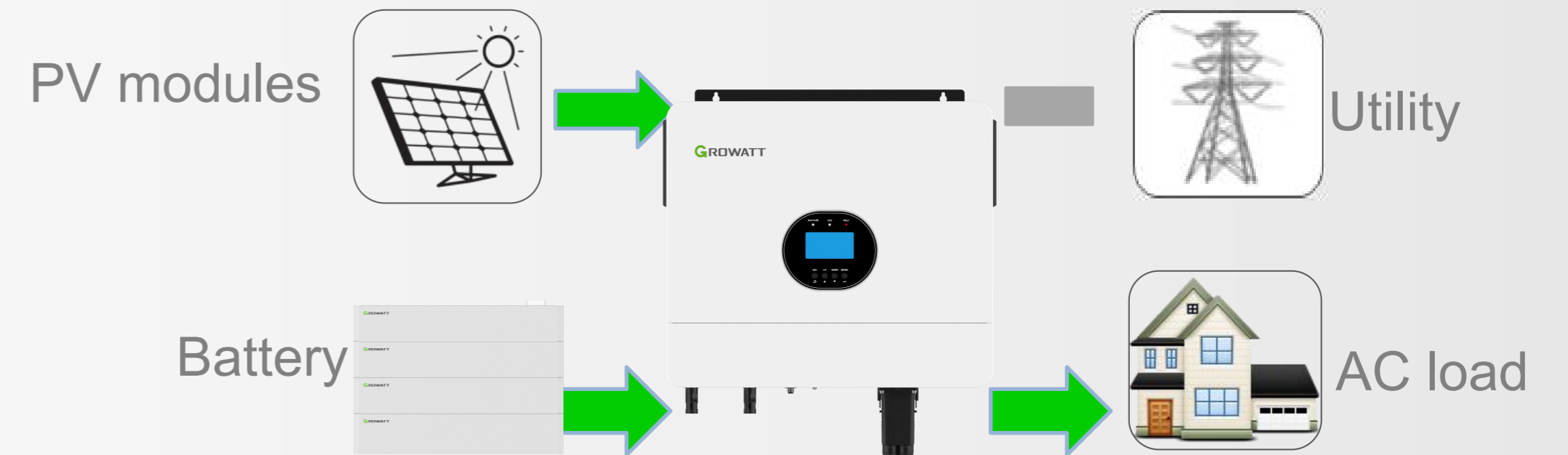

## 3. Battery discharge low voltage back to utility mode (44-51.2 Vdc can set)

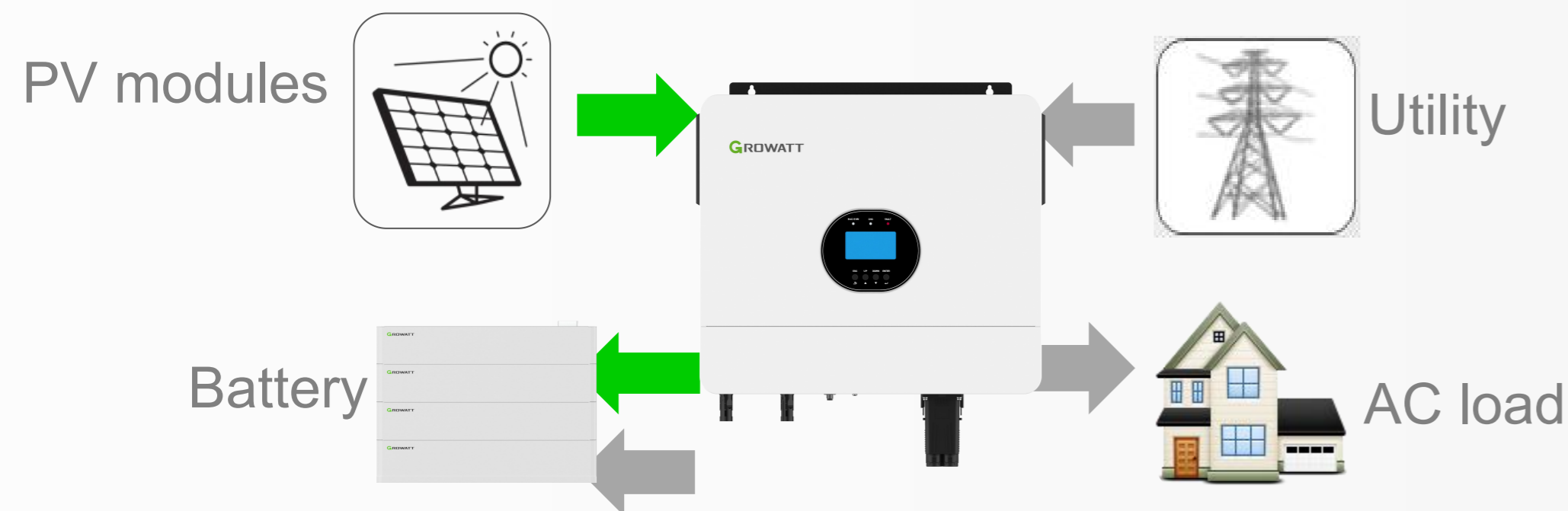

## 4. Utility charging voltage back to battery mode (48-58 Vdc can set)

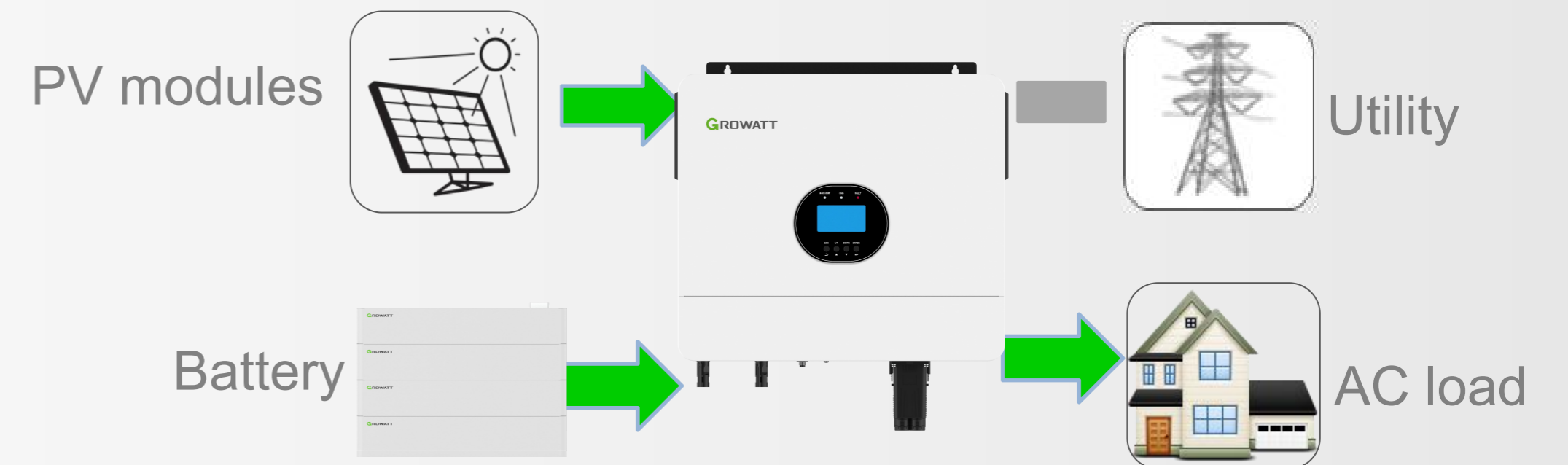



# Multiple Work Modes

Working mode: ( output UTI: utility first ; charging SOC : solar first)

## 1. Solar power is sufficient

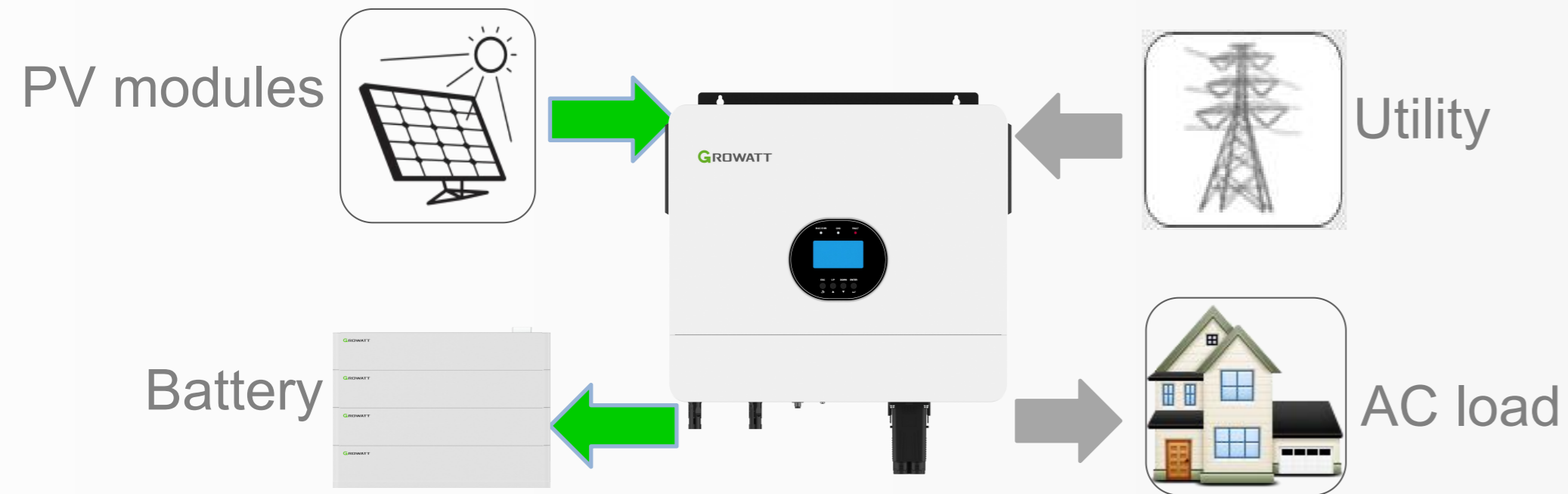

## 2. Solar power is not sufficient

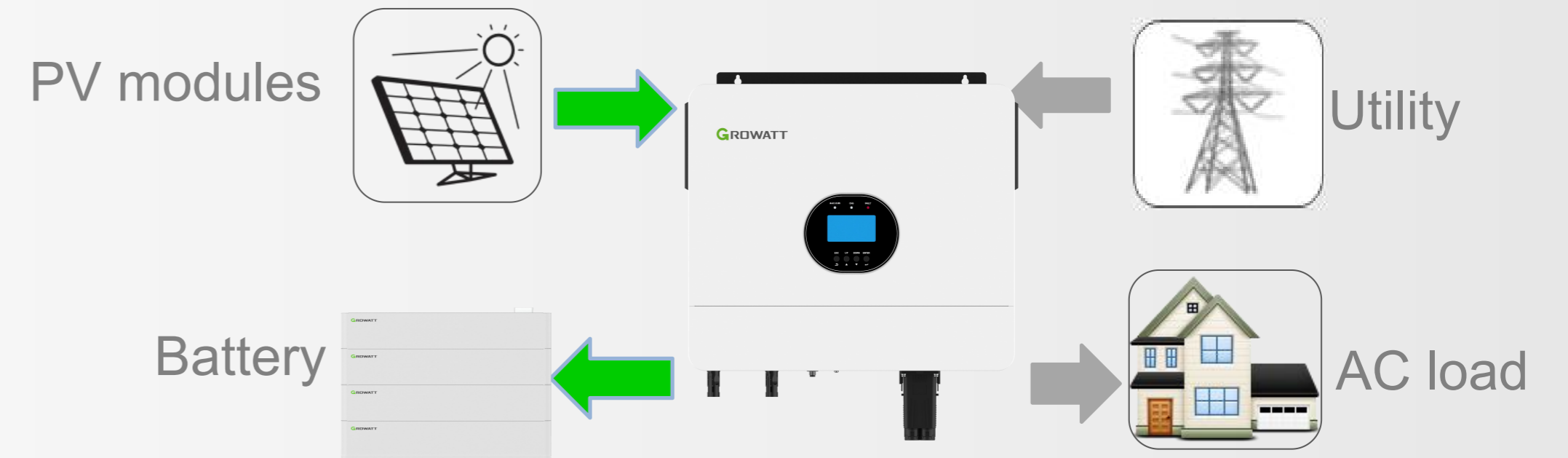

## 3. Solar power is not available

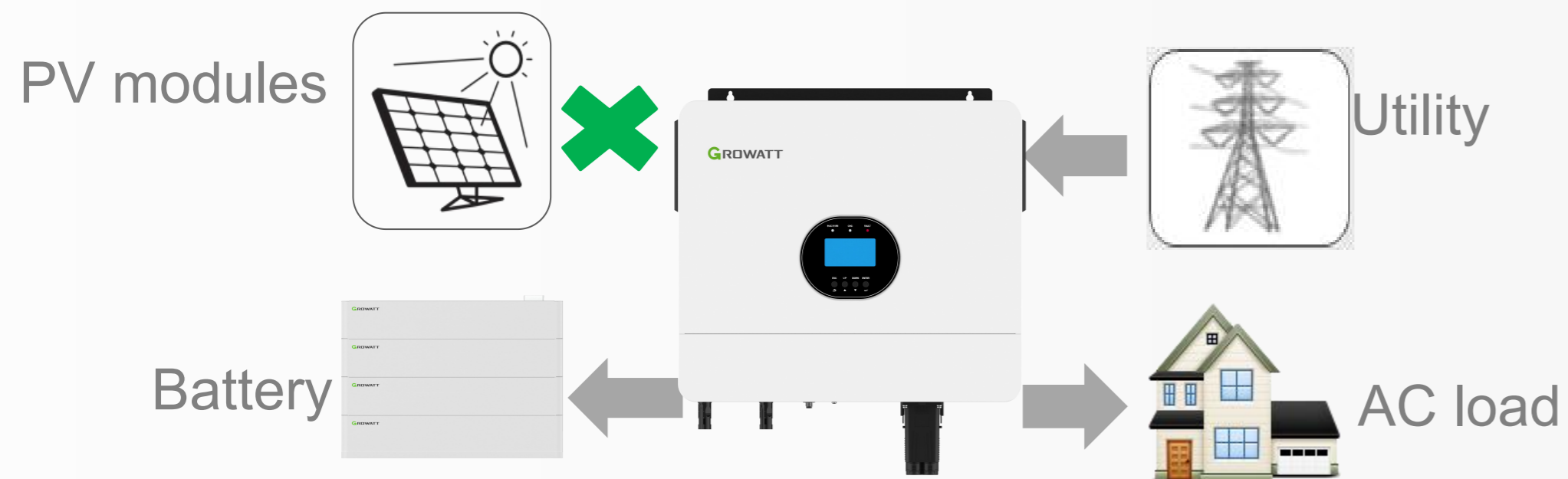

## 4. Utility power is not available

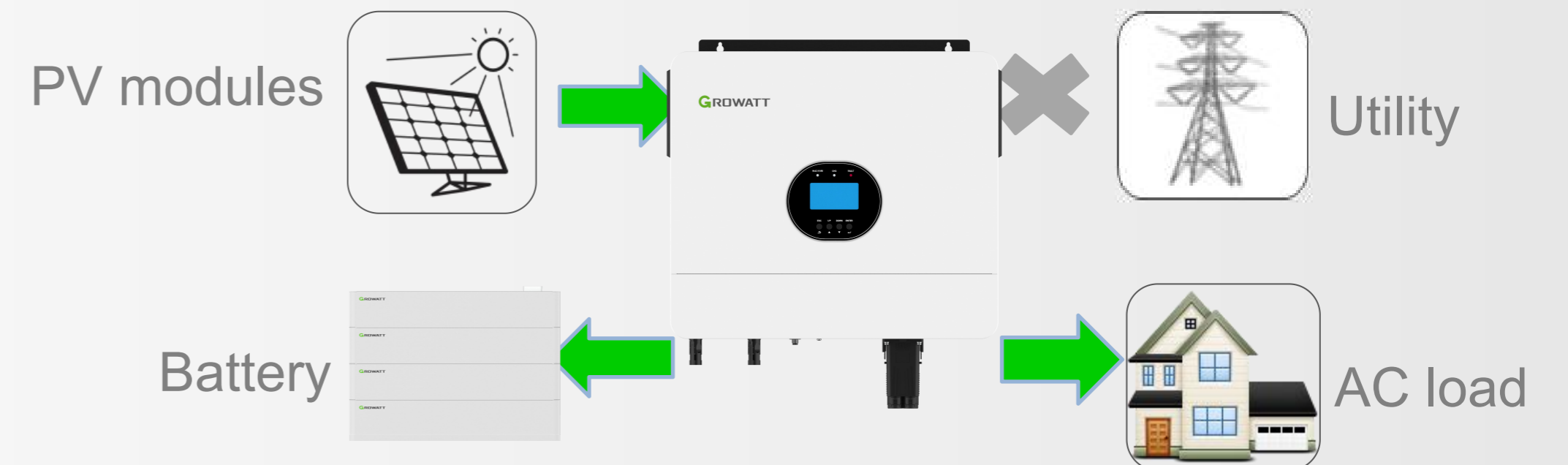

# Application Scenario 1 -- Power Backup

## Priority mode : SUB

1. Set output priority mode to SUB from program 01
2. Set battery charging mode to SNU from program 14

Solar power is sufficient (supply power to load and also charge the battery). When solar power is not available, utility power to the load and charge of the battery also

### Solar power is sufficient

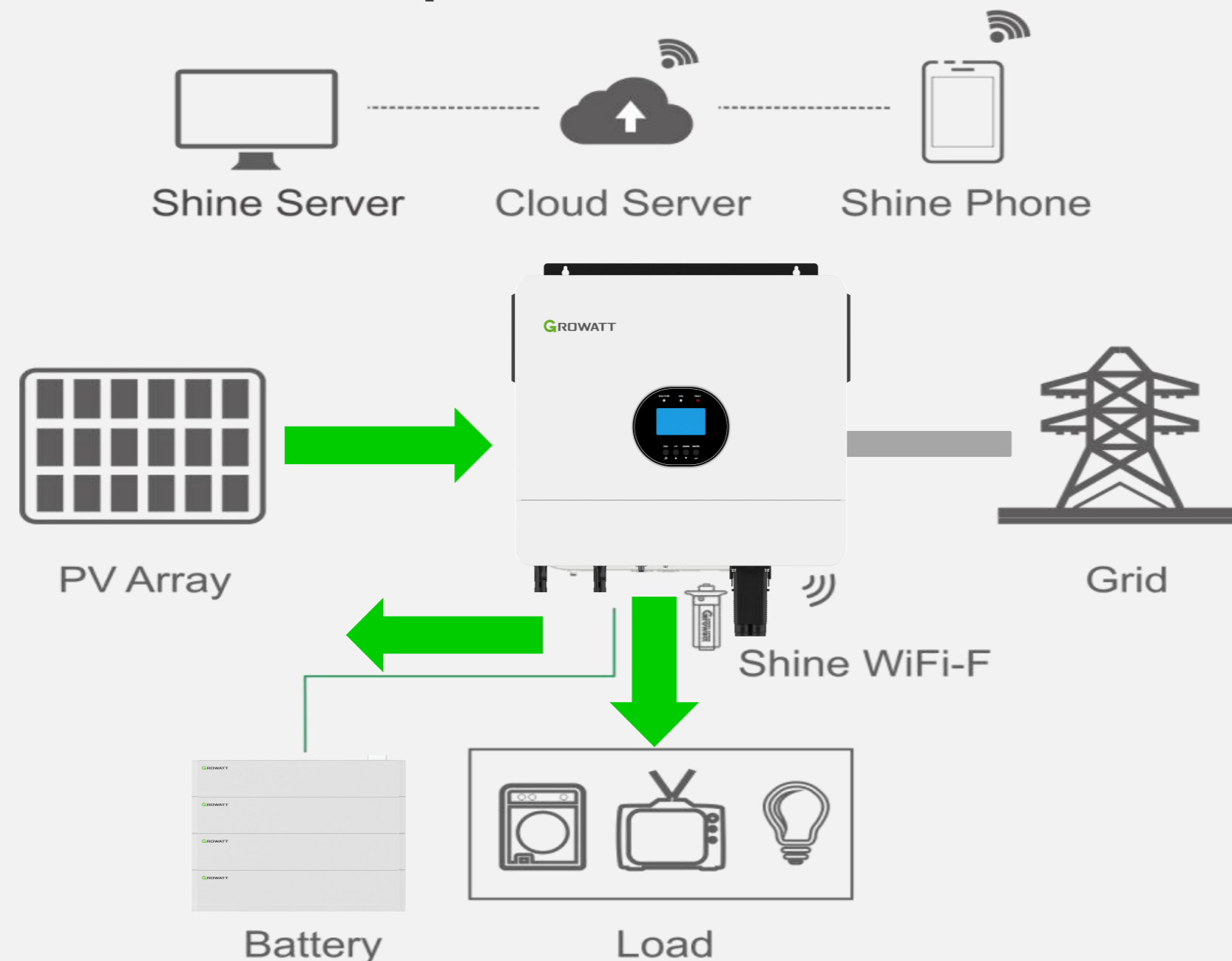

### Solar power is not sufficient

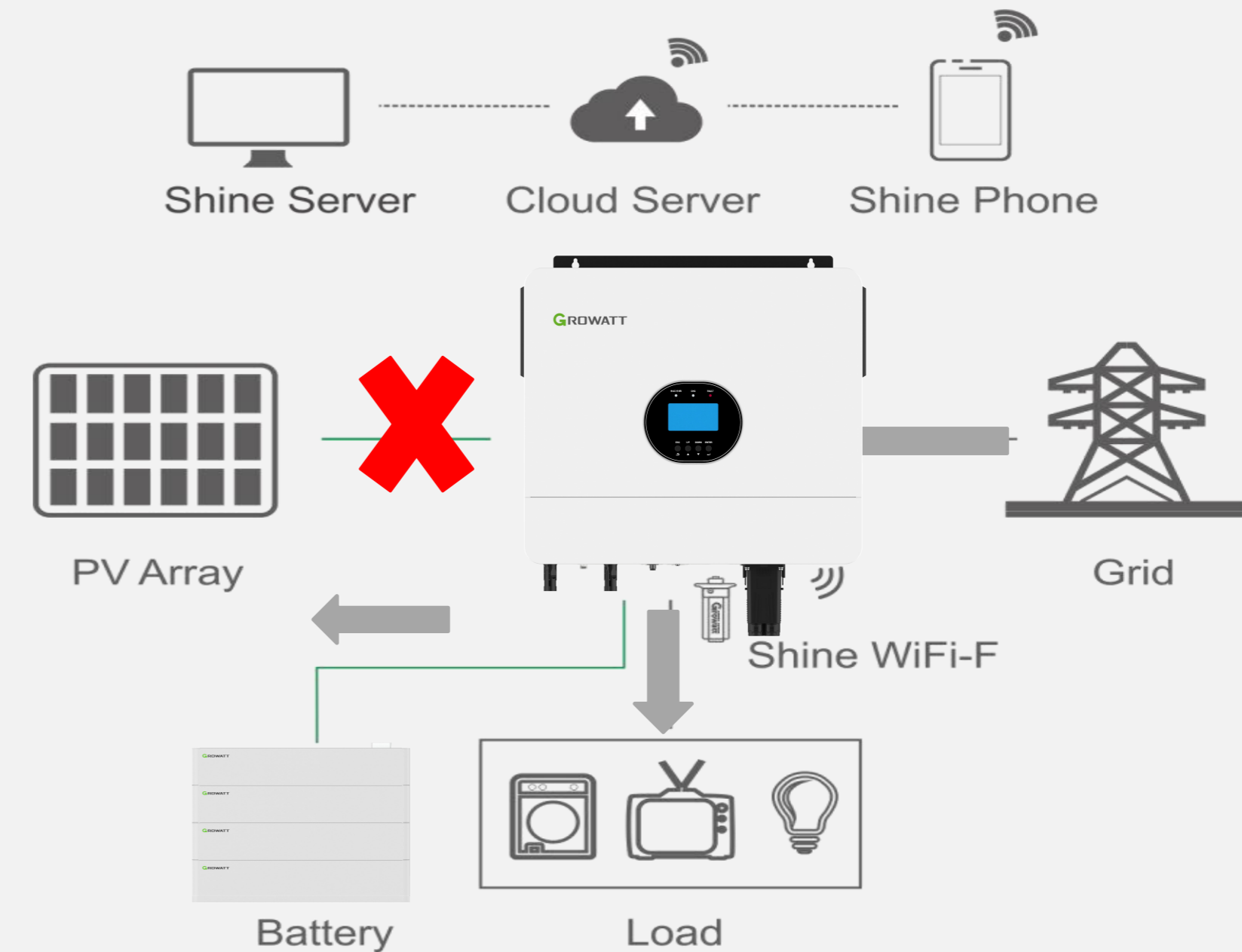



# Application Scenario 2 -- Reduce the Electricity Bill

## Priority mode : SBU

1. Set output priority mode to SBU from program 01
2. Set battery charging mode to OSO from program 14

Solar power is sufficient (supply power to load and also charge the battery). When solar power is not sufficient, solar and battery supply power to the load

### Solar power is sufficient

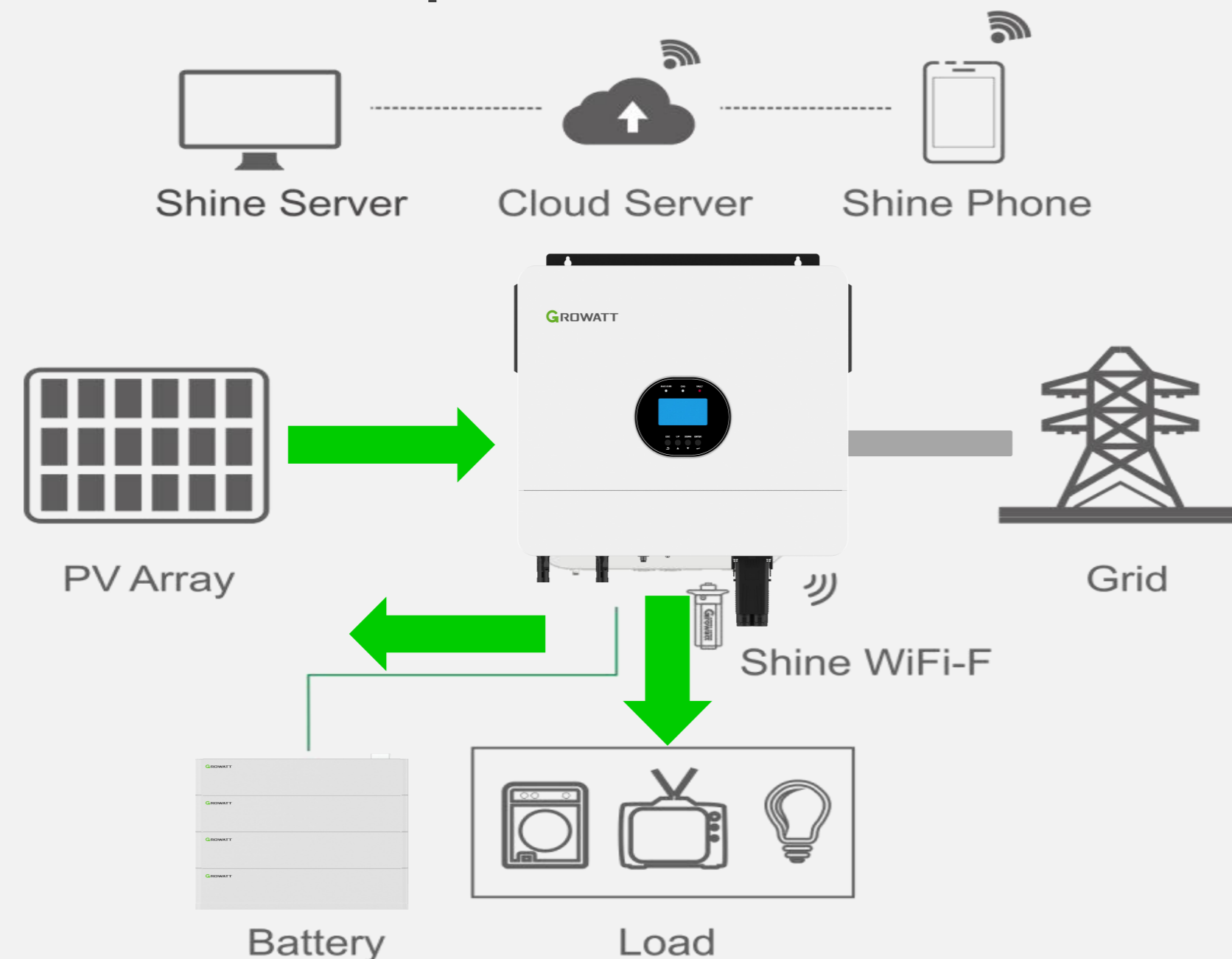

### Solar power is not sufficient

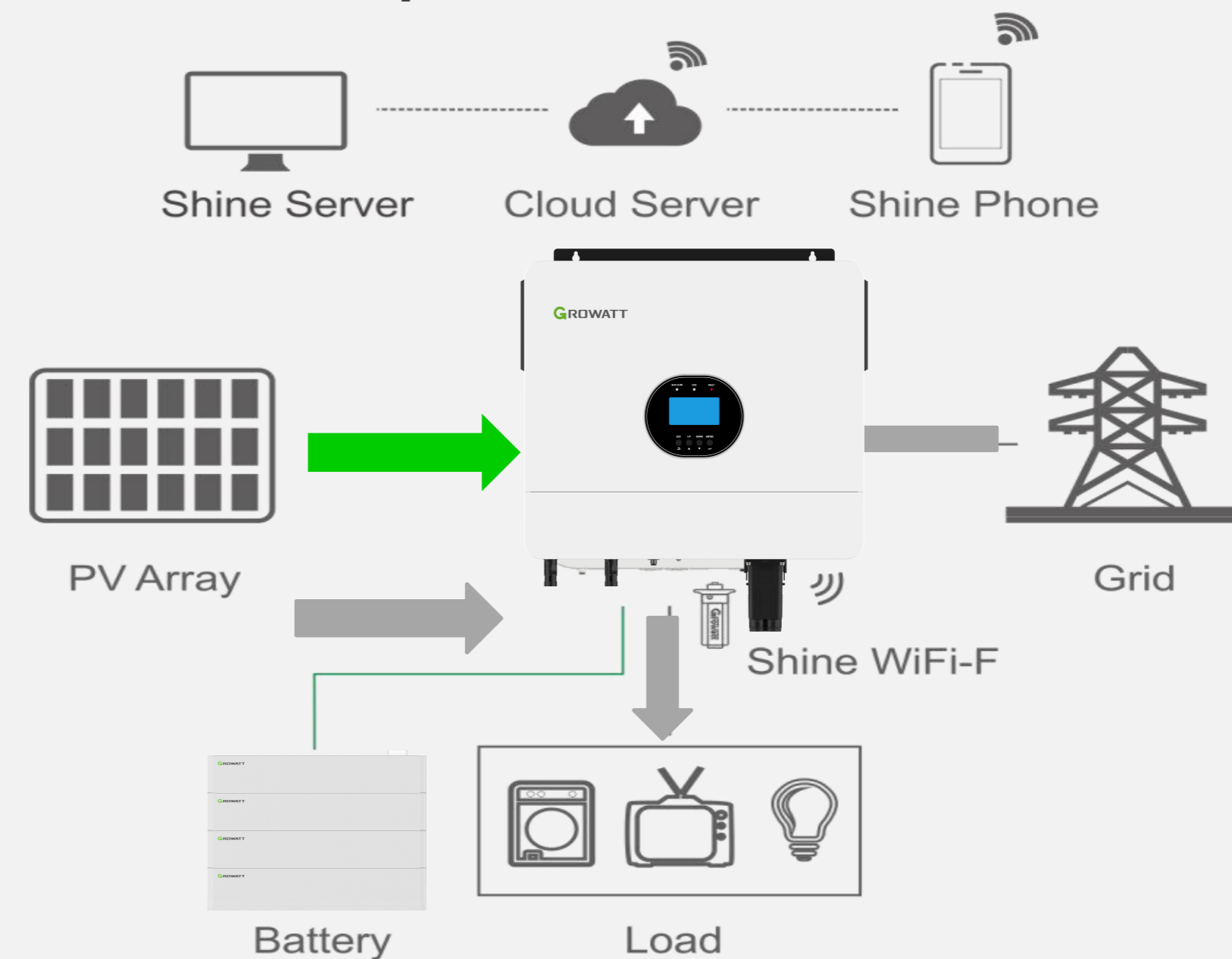

# Application Scenario 3 -- Lack of Sunlight Season

## Priority mode : UTL

1. Set output priority mode to UTI from program 01
2. Set battery charging mode to SNU from program 14

Solar power is sufficient (Utility power to load and also charge the battery). When utility power is not available, solar and battery supply power to the load.

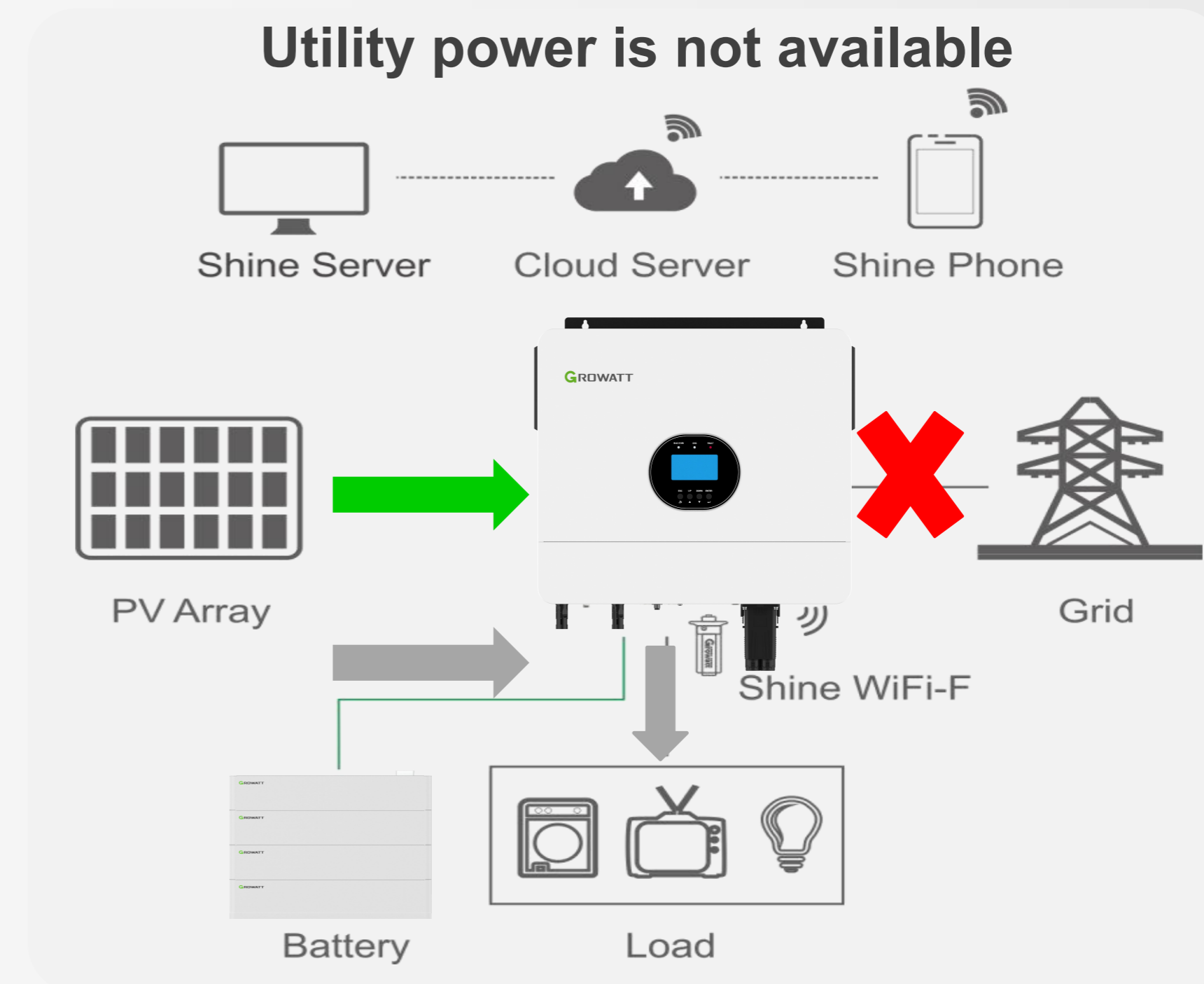
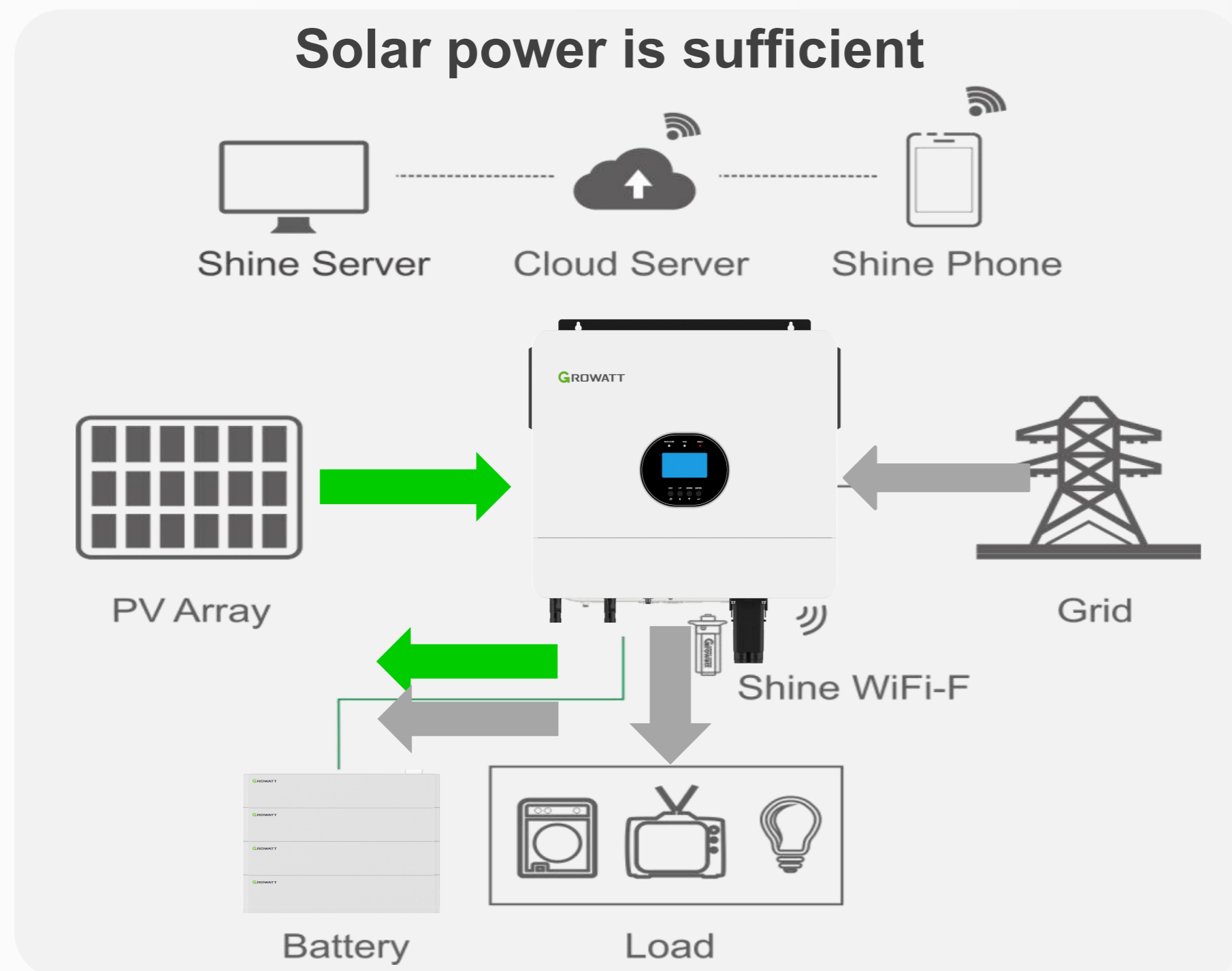



# Application Scenario 4 -- Off-Peak Charging

## Charging time setting ( all output modes are available)

1. set output priority mode from program 01
2. setting utility power charging battery time from program 49

The time of output power support and battery charging can be set during off-peak or peak time

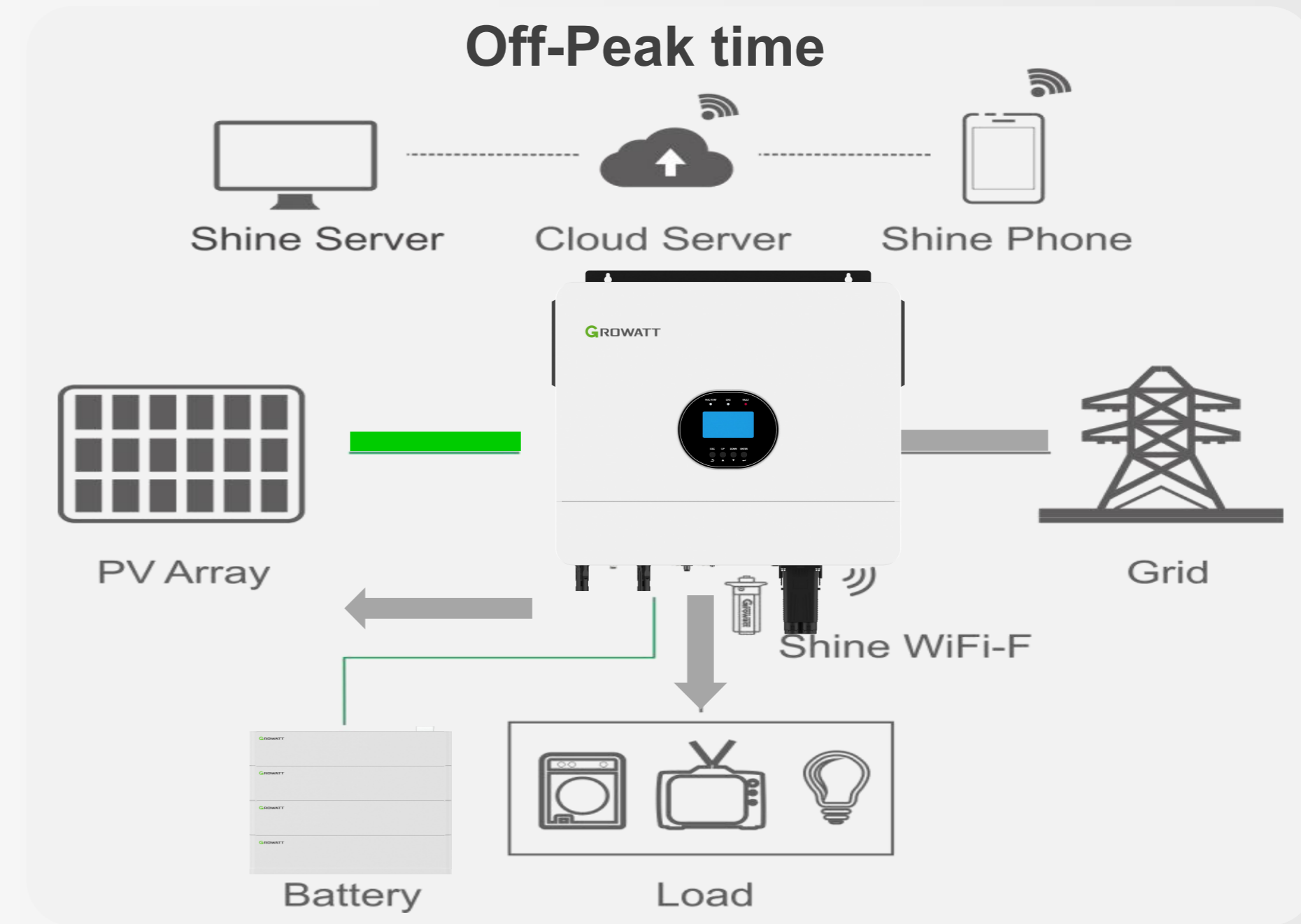
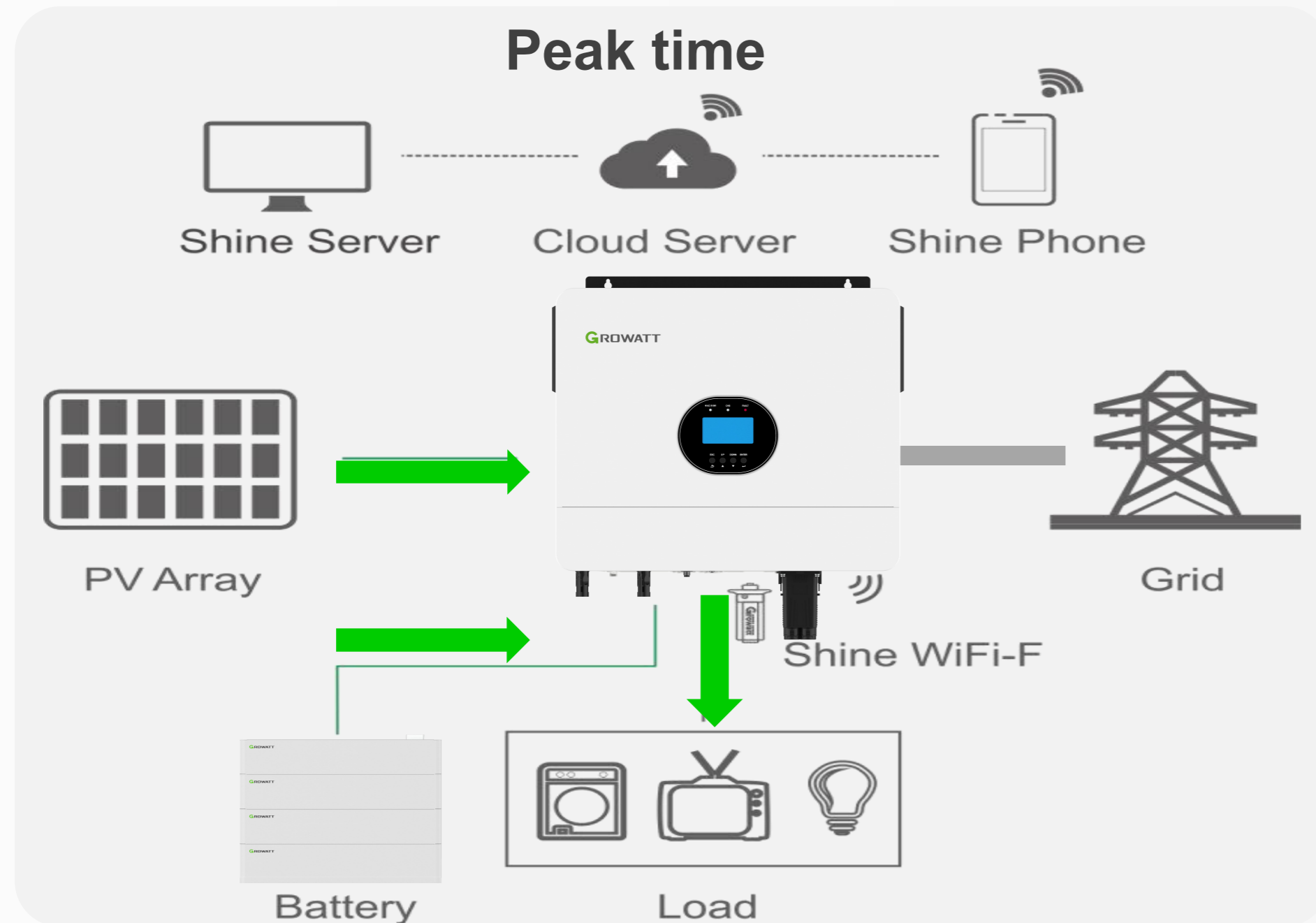

# Thanks!



Copyright© 2021 Growatt New Energy CO., LTD

All Rights Reserved. The information contained in this document is only for reference purpose and subject to change by company officials.

🔍 Growatt New Energy

